



SENSOR CONTROL PANEL WITH INTEGRATED WI-FI



SE Vento Expert W

EN

USER'S MANUAL



BLAUBERG
Ventilatoren

CONTENTS

Safety requirements.....	2
Purpose.....	3
Delivery set.....	3
Technical data.....	4
Mounting, connection and setup.....	4
Control.....	7

This user's manual is a main operating document intended for technical, maintenance, and operating staff.

The manual contains information about purpose, technical details, operating principle, design, and installation of the SE Vento Expert W unit and all its modifications.

Technical and maintenance staff must have theoretical and practical training in the field of ventilation systems and should be able to work in accordance with workplace safety rules as well as construction norms and standards applicable in the territory of the country.

The information in this user's manual is correct at the time of the document's preparation.

The Company reserves the right to modify the technical characteristics, design, or configuration of its products at any time in order to incorporate the latest technological developments.

No part of this publication may be reproduced, stored in a retrieval system, or transmitted, in any form or by any means in any information search system or translated into any language in any form without the prior written permission of the Company.

SAFETY REQUIREMENTS

- Please read the user's manual carefully prior to installing and operating the unit.
- All user's manual requirements as well as the provisions of all the applicable local and national construction, electrical, and technical norms and standards must be observed when installing and operating the unit.
- The warnings contained in the user's manual must be considered most seriously since they contain vital personal safety information.
- Failure to follow the rules and safety precautions noted in this user's manual may result in an injury or unit damage.
- After a careful reading of the manual, keep it for the entire service life of the unit.
- While transferring the unit control, the user's manual must be turned over to the receiving operator.

UNIT INSTALLATION AND OPERATION SAFETY PRECAUTIONS



- Disconnect the unit from power mains prior to any installation operations.



- Unpack the unit with care.



- The unit must be grounded!



- While installing the unit, follow the safety regulations specific to the use of electric tools.



- Do not change the power cable length at your own discretion.
- Do not bend the power cable.
- Avoid damaging the power cable.
- Do not put any foreign objects on the power cable.



- Do not lay the power cable of the unit in close proximity to heating equipment.

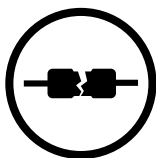

- Do not use damaged equipment or cables when connecting the unit to power mains.

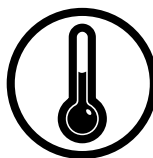

- Do not operate the unit outside the temperature range stated in the user's manual.
- Do not operate the unit in aggressive or explosive environments.



- Do not touch the unit controls with wet hands.
- Do not carry out the installation and maintenance operations with wet hands.

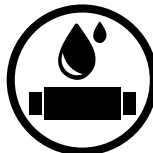

- Do not wash the unit with water.
- Protect the electric parts of the unit against ingress of water.



- Do not allow children to operate the unit.

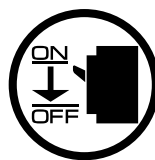

- Disconnect the unit from power mains prior to any technical maintenance.



- Do not store any explosive or highly flammable substances in close proximity to the unit.



- When the unit generates unusual sounds, odour, or emits smoke, disconnect it from power supply and contact the Seller.

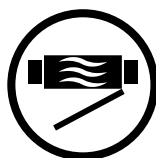

- Do not open the unit during operation.



- Do not direct the air flow produced by the unit towards open flame or ignition sources.



- Do not block the air duct when the unit is switched on.



- In case of continuous operation of the unit, periodically check the security of mounting.



- Do not sit on the unit and avoid placing foreign objects on it.

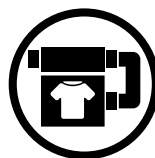

- Use the unit only for its intended purpose.



**THE PRODUCT MUST BE DISPOSED SEPARATELY AT THE END OF ITS SERVICE LIFE.
DO NOT DISPOSE THE UNIT AS UNSORTED DOMESTIC WASTE.**

PURPOSE

Nine-button sensor control panel with integrated Wi-Fi is designed to control the Vento Expert ventilator.

The sensor control panel is compatible with the following ventilator models:

- Vento Expert A30 WV.2
- Vento Expert A50-1 WV.2
- Vento Expert A85-1 WV.2
- Vento Expert A100-1 WV.2
- Vento Expert Duo A30-1 WV.2



THE UNIT SHOULD NOT BE OPERATED BY CHILDREN OR PERSONS WITH REDUCED PHYSICAL, MENTAL, OR SENSORY CAPACITIES, OR THOSE WITHOUT THE APPROPRIATE TRAINING.

THE UNIT MUST BE INSTALLED AND CONNECTED ONLY BY PROPERLY QUALIFIED PERSONNEL AFTER THE APPROPRIATE BRIEFING.

THE CHOICE OF UNIT INSTALLATION LOCATION MUST PREVENT UNAUTHORIZED ACCESS BY UNATTENDED CHILDREN.

DELIVERY SET

NAME	NUMBER
Control panel	1 pc.
Mounting box	1 pc.
User's manual	1 pc.
Packing	1 pc.

TECHNICAL DATA

Supply voltage, 50 (60) Hz [V]	110-230
Maximum current [A]	0.012
Cable type	2x0.35 mm ²
Temperature range [°C]	from +10 up to +45
Humidity range [%]	10-80 (without condensation)
Casing material	Plastic
Sensor surface material	Glass
SEC class	IP30
Weight [g]	190

DIMENSIONS

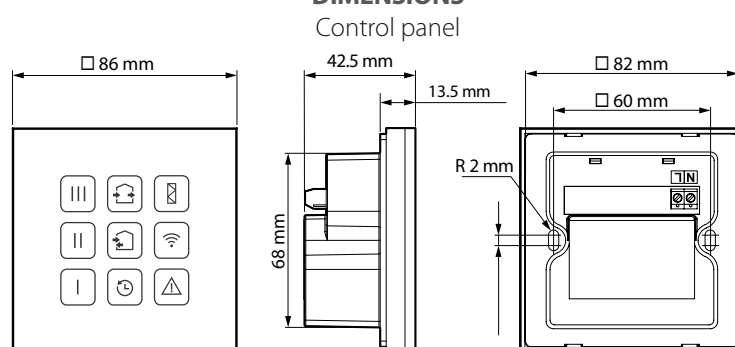

Wi-Fi data

Standard	IEEE 802.11 b/g/n
Frequency band [GHz 2.4]	2.4
Transmission power [mW] (dBm)	100 (+20)
Network	DHCP
WLAN safety	WPA, WPA2

Mounting box

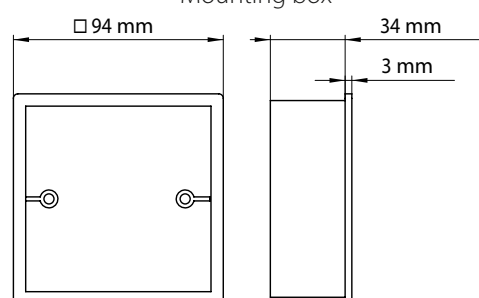

MOUNTING, CONNECTION AND SETUP



CUT OFF POWER SUPPLY BEFORE ANY OPERATIONS ARE PERFORMED



THE CONTROL PANEL MUST BE INSTALLED BY A QUALIFIED EXPERT ONLY, PROPERLY TRAINED AND HAVING THE REQUIRED TOOLS AND MATERIALS

CHOOSING LOCATION FOR CONTROL PANEL INSTALLATION

Examples of wireless alternatives and system operation scenarios

Example 1: direct control panel connection to master ventilator without using a router.

The control panel must be installed within the range of the Wi-Fi access point built into the master ventilator.

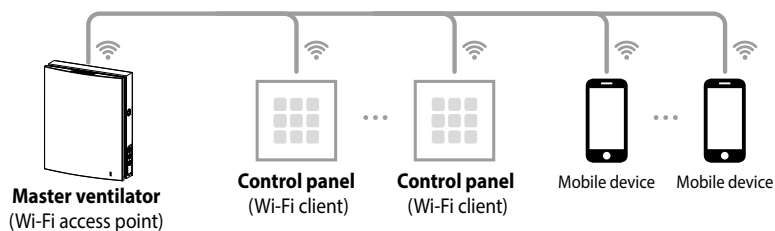

Set the ventilator to Wi-Fi access point master mode (see the ventilator user's manual).

- Install the control panel within the range of the Wi-Fi access point built into the ventilator.
 - Pair the control panel with the ventilator (see below).
- Note: the limitations specific to the number of devices that can be connected to the ventilator in the Wi-Fi access point mode are detailed in the ventilator user's manual.

Example 2: connection via a router with a single Wi-Fi access point.

The control panel can be installed outside the range of the Wi-Fi access point built into the master ventilator.

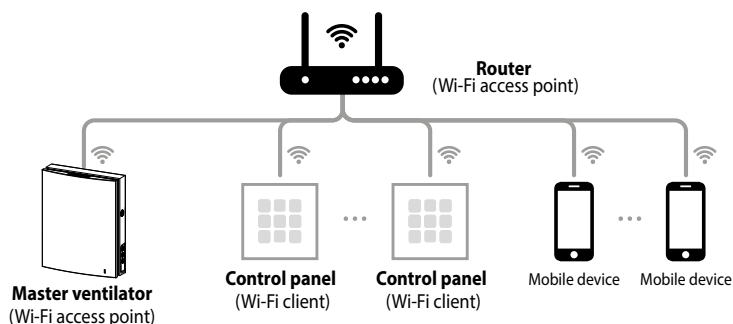

- Connect the router to the access point built into the router (see the ventilator user's manual).
- Bring the control panel within the range of the Wi-Fi access point built into the ventilator.
- Pair the control panel with the ventilator (see below).
- Install the control panels within the range of the Wi-Fi access point built into the ventilator.

Example 3: connection via a router connected to several Wi-Fi access points.

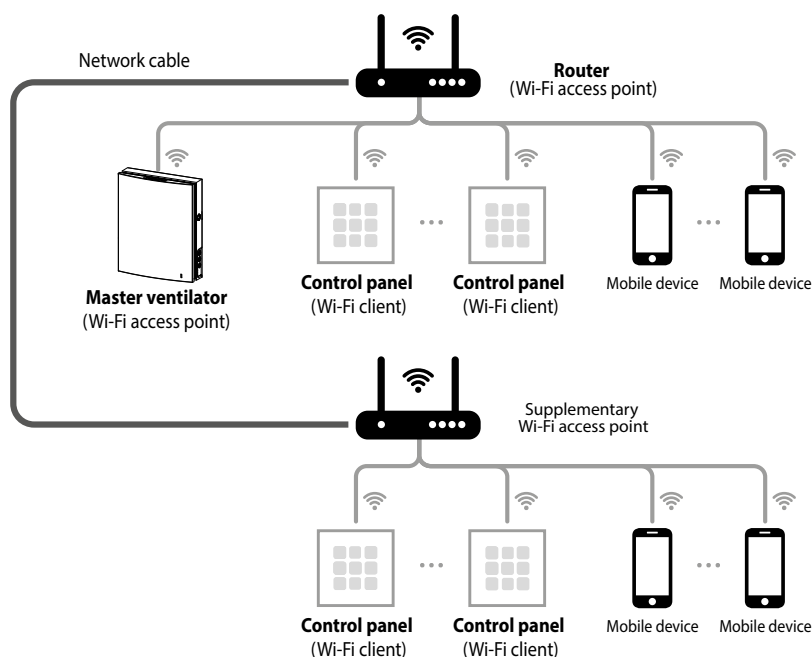

- Connect the router to one of the Wi-Fi access points (see ventilator user's manual).
- Pair the ventilator with the first group of the panels.
- Connect the ventilator to the other Wi-Fi access point (see ventilator user's manual).
- Pair the ventilator with the other group of the panels.





ATTENTION: IRRESPECTIVE OF THE SELECTED CONNECTION PATTERN THE PANEL MUST BE WITHIN THE RANGE OF THE WI-FI ACCESS POINT BUILT INTO THE VENTILATOR DURING THE PAIRING OF THE CONTROL PANEL WITH THE MASTER VENTILATOR.

PAIRING CONTROL PANEL WITH MASTER VENTILATOR

1. Set the ventilator to the Setup mode.

For more details see the ventilator user's manual.

2. Set the control panel to the Setup mode.

Press and hold the  button for at least 5 seconds until the    buttons start blinking simultaneously. Pairing success is confirmed by double blinking of all the control panel buttons. Upon successful pairing the control panel will exit the **Setup mode** immediately. If the pairing process fails to complete within 3 minutes, the panel automatically exits the **Setup mode** without altering the initial settings.

3. Exit the ventilator Setup mode.

For more details see the ventilator user's manual.

ATTENTION: THE PAIRING PROCESS MUST BE REPEATED AFTER EVERY CHANGE OF THE WI-FI PARAMETERS AND VENTILATOR PASSWORD (SEE VENTILATOR USER'S MANUAL).

1. Install the mounting box.

Installation inside a wall: make a niche in the wall, route the necessary wires and cables to the control panel mounting location and secure it in place.

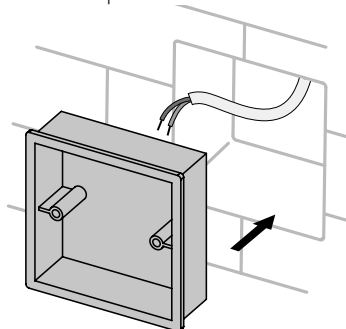

Installation on a wall surface: route the necessary wires and cables to the control panel mounting location, drill holes and secure the box to the wall with self-tapping screws (purchased separately).

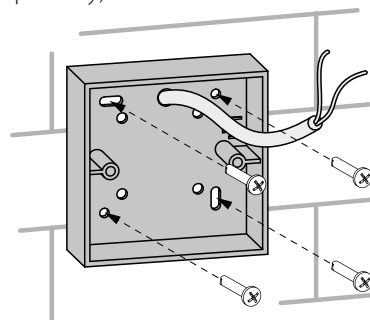

2. Connect the control panel according to the electrical connections diagram.

110-230 V / 50(60) Hz

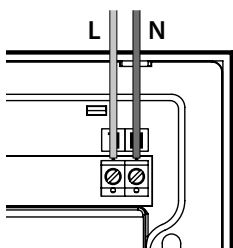

3. Befestigen Sie die Leiterplatte mit den Sensorelementen am Gehäuse. Dann fixieren Sie das Glas-Bedienfeld, drücken Sie es am Rahmen an, bis es einrastet.

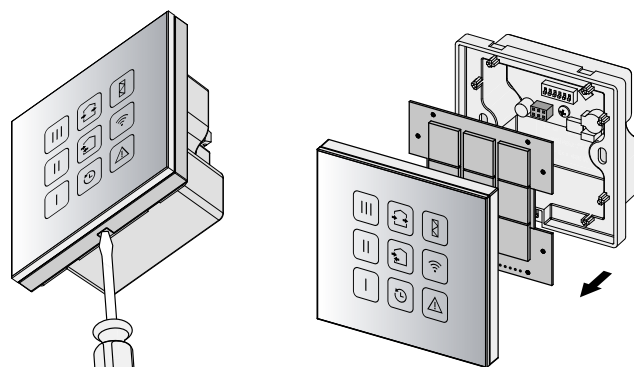

4. Fasten the control panel casing to the mounting box with screws. The screws used for fastening the panel to the mounting box are included with the unit.

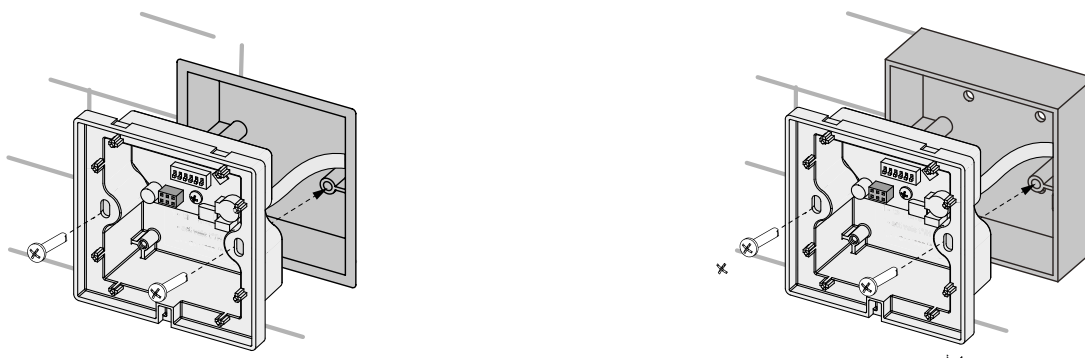















5. Fasten the sensor board to the casing, and then the glass panel by pressing it until it clicks into place.



CONTROL

The master ventilator is controlled by means of the buttons on the touch-sensitive control panel.

	Ventilator connection status indicator. The indicator glows steadily while the ventilator connection is live.
  	These buttons are used to enable/disable the ventilator, and select speed 1, 2 or 3. The buttons remain dark in the Standby mode. The buttons glow steadily while speed 1, 2 or 3 is enabled. The indicators blink intermittently if the Manual Speed Setup mode is selected.
	This button activates the Heat recovery mode.
	This button activates the Ventilation mode.
	This button activates the Party mode (speed 3 enabled by the timer set to 4 hours by default) or the Night mode (speed 1 enabled by the timer set to 8 hours by default). To activate the Party mode, press the  button and then immediately press the  button. To activate the Night mode, press the  button and then immediately press the  button.
	The filter contamination indicator activates automatically after 90 hours of unit operation. Respond to the alert by replacing or cleaning the filters. After replacing filters in all the ventilators reset the filter timer. To reset the timer, press and hold the  indicator for 5 seconds until all the buttons blink twice.
	The indicator blinks if the (Master) ventilator connection is down. This button starts to glow steadily in case of an emergency motor shutdown. To reset the alarm, press and hold the button for 5 seconds. After that all the buttons blink twice to alert the user that the button can be released.



BLAUBERG
Ventilatoren

