



AXIAL FAN



EN

**Trio
Trio One**

User's manual

CONTENTS

Delivery set	8
Brief description	8
Operation guidelines	8
Designation key	9
Mounting.....	10
Electronics operation algorithm	12
Technical maintenance.....	14
Troubleshooting.....	14
Storage and transportation regulations.....	15
Manufacturer's warranty	16

This user's manual is a main operating document intended for technical, maintenance, and operating staff.

The manual contains information about purpose, technical details, operating principle, design, and installation of the Trio/Trio One unit and all its modifications.

Technical and maintenance staff must have theoretical and practical training in the field of ventilation systems and should be able to work in accordance with workplace safety rules as well as construction norms and standards applicable in the territory of the country.



PLEASE READ THE USER'S MANUAL CAREFULLY PRIOR TO INSTALLING, CONNECTION TO POWER MAINS AND OPERATING THE UNIT.

THE MANUFACTURING COMPANY SHALL NOT BE RESPONSIBLE FOR DAMAGE TO HEALTH AND PROPERTY OF THE CUSTOMER CAUSED BY THE CUSTOMER'S VIOLATING THE USER'S MANUAL.

FOLLOW THE USER'S MANUAL REQUIREMENTS TO ENSURE DURABLE OPERATION OF THE UNIT, ITS MECHANICAL AND ELECTRICAL RELIABILITY.

KEEP THIS USER'S MANUAL.

This unit is not intended for use by persons (including children) with reduced physical, sensory or mental capabilities, or lack of experience and knowledge, unless they have been given supervision or instruction concerning use of the unit by a person responsible for their safety.

Children should be supervised to ensure that they do not play with the unit.

This appliance can be used by children aged from 8 years and above and persons with reduced physical, sensory or mental capabilities or lack of experience and knowledge if they have been given supervision or instruction concerning use of the appliance in a safe way and understand the hazards involved.

Cleaning and user maintenance shall not be made by children without supervision.

Children shall not play with the appliance.

Precautions must be taken to avoid the back-flow of gases into the room from the open flue of gas or other fuel-burning appliances.

The appliance may adversely affect the safe operation of appliances burning gas or other fuels (including those in other rooms) due to back flow of combustion gases. These gases can potentially result in carbon monoxide poisoning. After installation of the unit the operation of flued gas appliances should be tested by a competent person to ensure that back flow of combustion gases does not occur.

Connection to the mains must be made through a disconnecting device, which is integrated into the fixed wiring system in accordance with the wiring rules for design of electrical units, and has a contact separation in all poles that allows for full disconnection under overvoltage category III conditions.

Ensure that the unit is switched off from the supply mains before removing the guard.

All operations described in this manual must be performed by qualified personnel only, properly trained and qualified to install, make electrical connections and maintain ventilation units.

Do not attempt to install the product, connect it to the mains, or perform maintenance yourself.

This is unsafe and impossible without special knowledge.

Disconnect the power supply prior to any operations with the unit.

All user's manual requirements as well as the provisions of all the applicable local and national construction, electrical, and technical norms and standards must be observed when installing and operating the unit.

Disconnect the unit from the power supply prior to any connection, servicing, maintenance, and repair operations.

Connection of the unit to power mains is allowed by a qualified electrician with a work permit for the electric units up to 1000 V after careful reading of the present user's manual.

Check the unit for any visible damage of the impeller, the casing, and the grille before starting installation. The casing internals must be free

of any foreign objects that can damage the impeller blades.

While mounting the unit, avoid compression of the casing!

Deformation of the casing may result in motor jam and excessive noise.

Misuse of the unit and any unauthorised modifications are not allowed.

Do not expose the unit to adverse atmospheric agents (rain, sun, etc.).

Transported air must not contain any dust or other solid impurities, sticky substances, or fibrous materials.

Do not use the unit in a hazardous or explosive environment containing spirits, gasoline, insecticides, etc.

Do not close or block the intake or extract vents in order to ensure the efficient air flow.

Do not sit on the unit and do not put objects on it.

The information in this user's manual was correct at the time of the document's preparation.

The Company reserves the right to modify the technical

characteristics, design, or configuration of its products at any time in order to incorporate the latest technological developments.

Never touch the unit with wet or damp hands.

Never touch the unit when barefoot.

BEFORE INSTALLING ADDITIONAL EXTERNAL DEVICES, READ THE RELEVANT USER MANUALS.



**THE PRODUCT MUST BE DISPOSED SEPARATELY AT THE END OF ITS SERVICE LIFE.
DO NOT DISPOSE THE UNIT AS UNSORTED DOMESTIC WASTE**

DELIVERY SET

Fan	- 1 pc.
Screws with dowels	- 4 pcs.
Plastic screwdriver	- 1 pc. (only for the models with a timer)
User's manual	- 1 pc.
Packing box	- 1 pc.
Insulating gasket	- 1 pc.

BRIEF DESCRIPTION

The unit described herein is an axial fan for exhaust ventilation of small and medium-sized utility spaces.

The fan is designed for connection to Ø 100 or 150 mm air ducts, depending on the model.

OPERATION GUIDELINES

The fan is rated for connection to single-phase AC power mains.

Power mains parameters are stated on the unit packaging and/or the label on the unit casing.

Ingress protection rating against access to hazardous parts and water ingress is IP44.

The fan is rated for indoor operation at ambient temperatures ranging from +1 °C to +40 °C.

The unit is rated as the Class II (220-240 V, 50 Hz/220 V, 60 Hz) or the Class III (12 V/50 Hz) electrical appliance and requires no grounding.

Power mains parameters are stated on the unit packaging and/or the label on the unit casing.

WARNING! Do not operate the fan outside the specified temperature range.

DESIGNATION KEY

Trio V2 100 S e 12

Unit voltage:

_ : 220-240 V/50 Hz

220 V/60 Hz: supply voltage 220 V, power frequency 60 Hz

12: low voltage motor 12 V/50 Hz

Differences from the baseline model

_ : ball bearing and a backdraft damper with a membrane of light by default

e: sliding bearing without a backdraft damper

e1: sliding bearing and a backdraft damper with a membrane of light polymer

e2: ball bearing without a backdraft damper

K1: ball bearing and a plastic petal backdraft damper

e K1: sliding bearing and a plastic petal backdraft damper

Additional options:

S: pull cord switch

T: turn-off delay timer

TR: turn-on and turn-off delay timer

ST: turn-off delay timer and pull cord switch

H: humidity sensor and turn-off delay timer

SH: humidity sensor, turn-off delay timer and pull cord switch

Outlet duct diameter [mm]

100/150

Motor modification:

_ : basic motor

V2: two-speed motor

Fan series

Trio/Trio One

Availability of options depending on the fan model

	e	e1	e2	K1	e K1	S	T	TR	ST	H	SH
Trio	+	+	+	+	+	+	+	+	+	+	+
Trio One	+	+	+	+	+	+	+	+	-	+	-

MOUNTING

The fan is designed for wall (with the motors on ball and slide bearings) or ceiling (with the motors on ball bearings only, L option) mounting and can be used for direct outdoor air exhaust through a round duct or a duct system.

In case of installation through a duct system, select the duct cross section in accordance with the fan size (Fig. 1).

1. When installing the fan with direct air discharge outside through the wall, be sure to install a ventilation grille with louvre shutters or a ventilation hood on the outside to prevent rainfall, snow, leaves, branches, etc. from entering the duct.

To reduce the risk of condensate forming in the duct, the space between the hole in the wall and the duct must be insulated.

Install the air duct with the minimum slope of 1...2° downwards to the outer wall side for condensate removal (Fig 2).

2. The duct system should not exceed 5 meters and have more than two bends.

3. During ceiling installation, vertical air discharge upwards is not allowed even if there is a protective outer hood on the roof.

For ceiling mounting and air discharge to the roof, the duct system must include a condensate drain (Fig. 3).

A condensate drain is not included in the delivery set of the fan and can be ordered separately.

Check the fan for any visible damages of the impeller, the casing and the grille before starting installation. The casing internals must be free of any foreign objects which can damage the impeller blades.

While mounting the unit, avoid compression of the casing!

Deformation of the casing may result in the motor jam and excessive noise.

Mark and drill the fan mounting holes, attach the insulation gasket, and install the fan.

Dowels and screws are designed for concrete and brick walls.

If the walls are made of the other material (drywall, wood, etc.), use the fasteners appropriate for these materials to fasten the fan (not supplied with the fan and must be purchased separately).

WARNING!

When the fan is equipped with a non-return valve, operation of the fan without the valve is prohibited.

The fan mounting sequence is shown in Fig. 4-12.

The fan wiring diagrams are shown in Fig. 13-18.

Terminal designations on wiring diagrams:

L — line

N — neutral

S — timer control line

S1 — external switch

QF — automatic switch

WARNING! The fans rated for 12 V power voltage (stated on the packing box and on the fan casing) connect to ~12 V power mains only!

WARNING! The power cable may only be laid through the hole in the casing provided by the manufacturer (Fig. 13). Laying the power cable through a manually drilled hole will not be the liability of the manufacturer and will void the warranty. The wire must be stripped of insulation by a maximum of 8 mm (Fig. 13).

After installation, pass this user's manual to the end user for reading.

The installation of the product is possible in the zones according to the table below, provided that the installation and connection are performed in accordance with the requirements of IEC 60364-7-701 (in the current version), as well as in accordance with the requirements of the national standards of the country of its installation.

Trio One models may be installed in Zone 1 of bathrooms where the product cannot be exposed to water jets other than shower spray.

Trio One	1 2 3
Trio	2 3

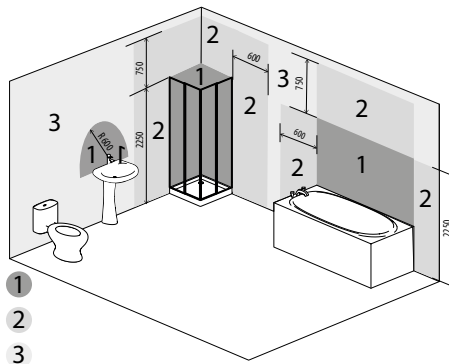

ELECTRONICS OPERATION ALGORITHM

The fan with the timer (T) activates upon control voltage application to the **S** input terminal by the **S1** external switch (e.g. indoor light switch). After the control voltage is off, the fan continues to operate within the time set by the timer ranging from 2 to 30 minutes. For the **ST** model, the fan is turned on/off with an internal cord switch.

The fan with the timer (TR) – when the control voltage is applied to the **S** input by an external switch **S1** (for example, switching on the room light), the turn-on delay timer is activated, and the fan blades do not rotate. The value of the turn-on delay time is adjustable in the range from 0 to 2 minutes. Select the adjustment range using the jumper on the timer board. After some turn-on delay time has elapsed, the fan turns on and the blades start rotating. After the control voltage is off, the fan continues to operate within the time set by the turn-off delay timer adjustable from 2 to 30 minutes.



The two-speed fan with the timer (V2 TR) operates at Speed 1 when the control voltage is applied to the **S** input with the **S1** external switch. The turn-on delay timer turns on, and the fan blades do not rotate. The value of the turn-on delay time is adjustable in the range from 0 to 2 minutes. After some turn-on delay time has elapsed, the fan switches to Speed 2. After disconnecting the control voltage, the fan runs for a time set by the turn-off delay timer (from 2 to 30 minutes), and switches to the first speed.

The fan with the timer and the humidity sensor (H) – the fan starts after the control voltage is supplied to the input terminal **S** or if indoor humidity level **H** exceeds the set point adjustable from ~60 % to ~90 %.

After the control voltage is off or the humidity level has decreased, the fan will keep running within the time set by the turn-off delay timer ranging from 2 to 30 minutes.

The two-speed fan with the timer and the humidity sensor (V2 H) switches to Speed 2 as the indoor humidity exceeds set level (adjustable from 60 % up to 90 %). As the indoor humidity level drops down to the set value, the fan keeps operating for 5 minutes and then switches to Speed 1. The fan can be controlled manually, for example, by a light switch.

When the control voltage is applied, the turn-on delay timer is activated for 45 seconds and the fan switches to the second speed. After disconnecting the control voltage, the fan runs for a time set by the turn-off delay timer (from 2 to 30 minutes), and switches to the first speed. To set the maximum humidity set point, set the potentiometer to **H_{max}** position (90 %).

-  **T_{on}** — To adjust the fan turn-on delay time, turn the control knob **T_{on}** clockwise to increase and counter-clockwise to decrease the turn-on delay time set point, adjustable from 0 up to 2 minutes.
-  **T_{off}** — To adjust the fan turn-off delay time, turn the control knob **T_{off}** clockwise to increase and counter-clockwise to decrease the turn-off delay time set point, adjustable from 2 up to 30 minutes.
-  **H** — To adjust the humidity set point, turn the control knob **H** clockwise to increase and counter-clockwise to decrease the humidity sensor set point, adjustable from 60 % up to 90 %.

The fan delivery set includes a specially designed plastic screwdriver for fan settings adjustments. Use it to change the turn-on and turn-off delay time and the humidity set point.

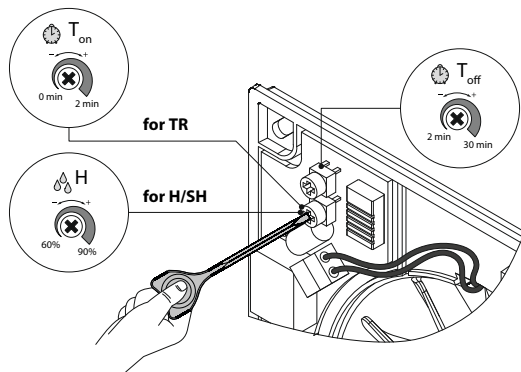

DO NOT USE A METAL SCREWDRIVER, KNIFE, ETC. FOR ADJUSTMENT OPERATIONS NOT TO DAMAGE THE CIRCUIT BOARD

TECHNICAL MAINTENANCE

The fan maintenance periodicity is at least once per 6 months.

Maintenance steps:

- Disconnect the fan from power supply and make sure electricity has been turned off (Fig. 19).
- Remove the front and the decorative panels, wipe the fan with a dry cloth or a brush (Fig. 20).
- Clean the front panel under running water (Fig. 21).
- Wipe the fan surfaces dry.
- Cover the fan with the front panel.
- Connect power supply to the fan (Fig. 22).

WARNING! Do not allow water or liquid come into contact with electric components!

TROUBLESHOOTING

Problem	Possible reasons	Troubleshooting
When the unit is connected to power mains, the fan does not rotate and does not respond to any controls.	No power supply.	Make sure the power supply line is connected correctly, otherwise troubleshoot the connection error.
	Internal connection fault.	Contact the Seller.
Low air flow.	The ventilation system is clogged.	Clean the ventilation system.
Increased noise, vibration.	The impeller is clogged.	Clean the impeller.
	The fan is not secured well or is not mounted properly.	Troubleshoot the installation error.
	The ventilation system is clogged.	Clean the ventilation system.

STORAGE AND TRANSPORTATION REGULATIONS

- Store the unit in the manufacturer's original packaging box in a dry closed ventilated premise with temperature range from +5 °C to +40 °C and relative humidity up to 70 %.
- Storage environment must not contain aggressive vapors and chemical mixtures provoking corrosion, insulation, and sealing deformation.
- Use suitable hoist machinery for handling and storage operations to prevent possible damage to the unit.
- Follow the handling requirements applicable for the particular type of cargo.
- The unit can be carried in the original packaging by any mode of transport provided proper protection against precipitation and mechanical damage. The unit must be transported only in the working position.
- Avoid sharp blows, scratches, or rough handling during loading and unloading.
- Prior to the initial power-up after transportation at low temperatures, allow the unit to warm up at operating temperature for at least 3-4 hours.

MANUFACTURER'S WARRANTY

The product is in compliance with EU norms and standards on low voltage guidelines and electromagnetic compatibility. We hereby declare that the product complies with the provisions of Electromagnetic Compatibility (EMC) Directive 2014/30/EU of the European Parliament and of the Council, Low Voltage Directive (LVD) 2014/35/EU of the European Parliament and of the Council and CE-marking Council Directive 93/68/EEC. This certificate is issued following test carried out on samples of the product referred to above.

The manufacturer hereby warrants normal operation of the unit for 60 months after the retail sale date provided the user's observance of the transportation, storage, installation, and operation regulations. Should any malfunctions occur in the course of the unit operation through the Manufacturer's fault during the guaranteed period of operation, the user is entitled to get all the faults eliminated by the manufacturer by means of warranty repair at the factory free of charge. The warranty repair includes work specific to elimination of faults in the unit operation to ensure its intended use by the user within the guaranteed period of operation. The faults are eliminated by means of replacement or repair of the unit components or a specific part of such unit component.

The warranty repair does not include:

- routine technical maintenance
- unit installation/dismantling
- unit setup

To benefit from warranty repair, the user must provide the unit, the user's manual with the purchase date stamp, and the payment paperwork certifying the purchase. The unit model must comply with the one stated in the user's manual. Contact the Seller for warranty service.

The manufacturer's warranty does not apply to the following cases:

- User's failure to submit the unit with the entire delivery package as stated in the user's manual including submission with missing component parts previously dismantled by the user.
- Mismatch of the unit model and the brand name with the information stated on the unit packaging and in the user's manual.
- User's failure to ensure timely technical maintenance of the unit.
- External damage to the unit casing (excluding external modifications as required for installation) and internal

components caused by the user.

- Redesign or engineering changes to the unit.
- Replacement and use of any assemblies, parts and components not approved by the manufacturer.
- Unit misuse.
- Violation of the unit installation regulations by the user.
- Violation of the unit control regulations by the user.
- Unit connection to power mains with a voltage different from the one stated in the user's manual.
- Unit breakdown due to voltage surges in power mains.
- Discretionary repair of the unit by the user.
- Unit repair by any persons without the manufacturer's authorization.
- Expiration of the unit warranty period.
- Violation of the unit transportation regulations by the user.
- Violation of the unit storage regulations by the user.
- Wrongful actions against the unit committed by third parties.
- Unit breakdown due to circumstances of insuperable force (fire, flood, earthquake, war, hostilities of any kind, blockades).
- Missing seals if provided by the user's manual.
- Failure to submit the user's manual with the unit purchase date stamp.
- Missing payment paperwork certifying the unit purchase.



FOLLOWING THE REGULATIONS STIPULATED HEREIN WILL ENSURE A LONG AND TROUBLE-FREE OPERATION OF THE UNIT



USER'S WARRANTY CLAIMS SHALL BE SUBJECT TO REVIEW ONLY UPON PRESENTATION OF THE UNIT, THE PAYMENT DOCUMENT AND THE USER'S MANUAL WITH THE PURCHASE DATE STAMP

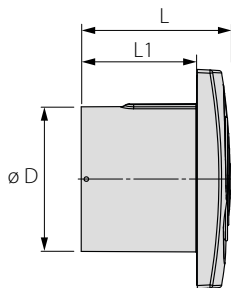
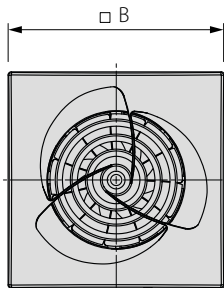

	D, MM	B, MM	L, MM	L1, MM
Trio 100/ Trio One 100	100	150	102	79
Trio 150	150	206	123	100

1.

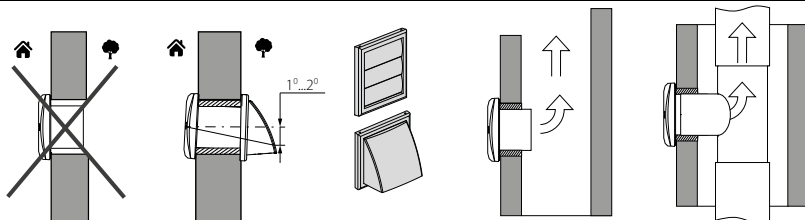

2.

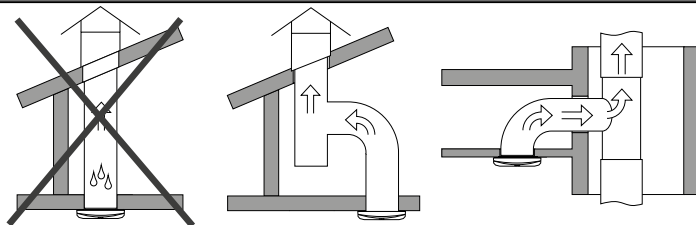

3.

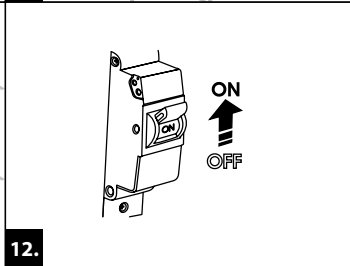
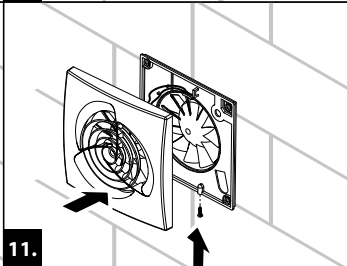
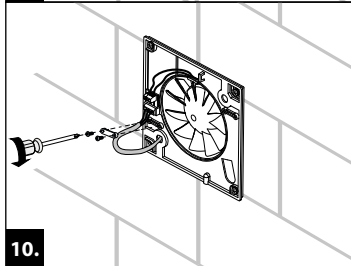
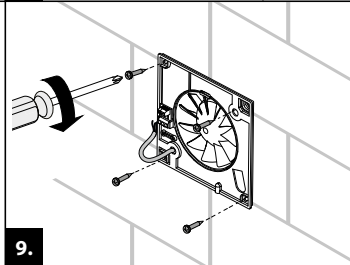
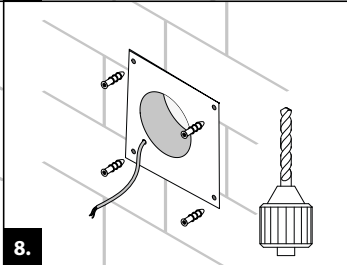
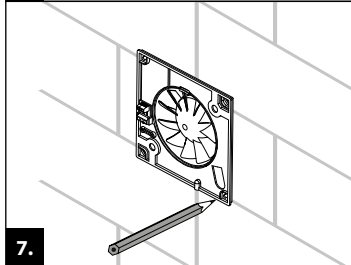
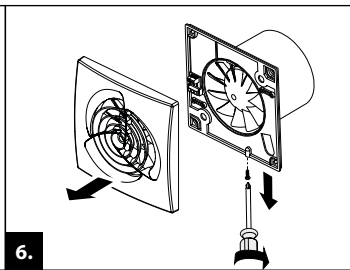
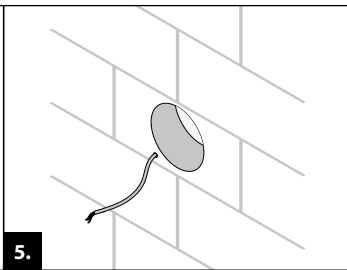
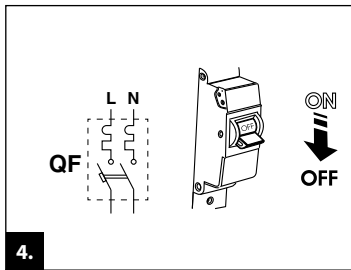

... 100/150

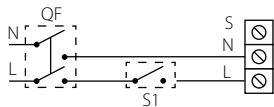

... 100/150 T

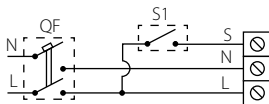

... 100/150 ST

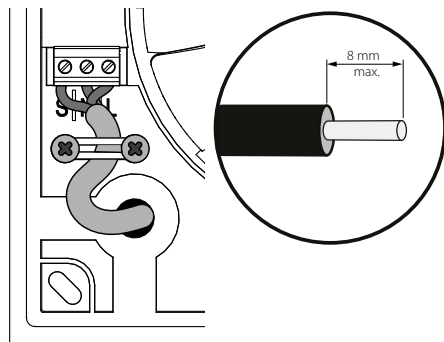
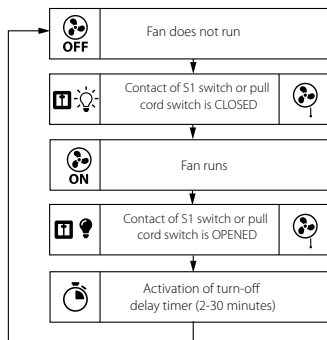
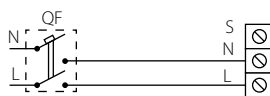

... 100/150 TR

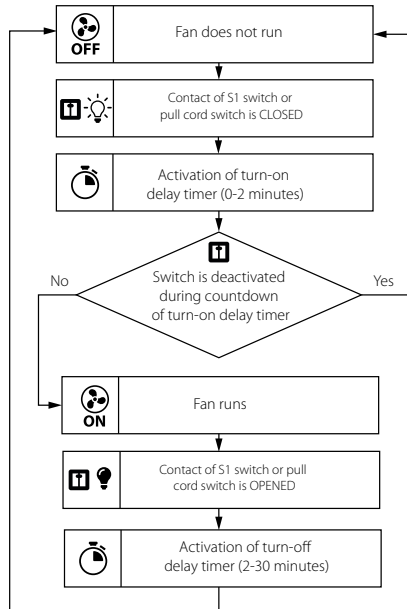
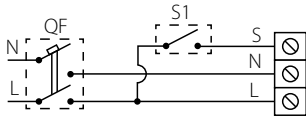

... V2 100/150 TR

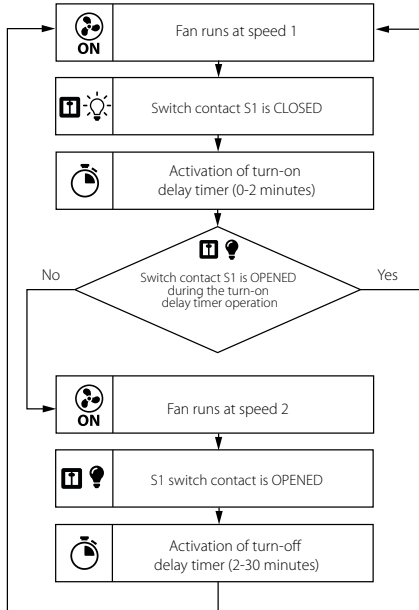
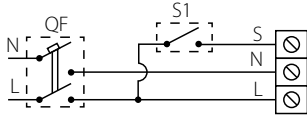

... V2 100/150 H

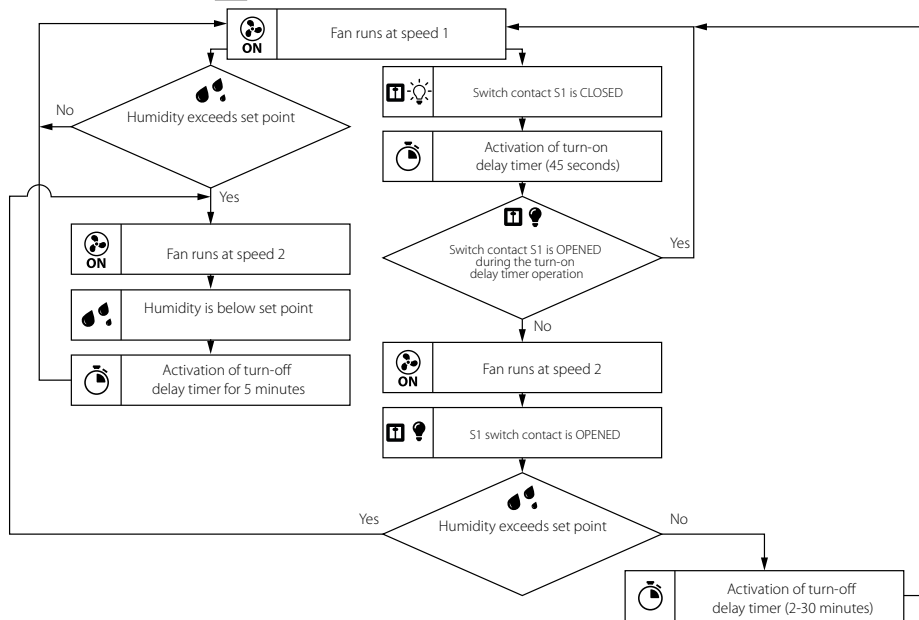
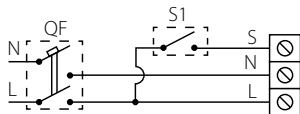

... V2 100/150

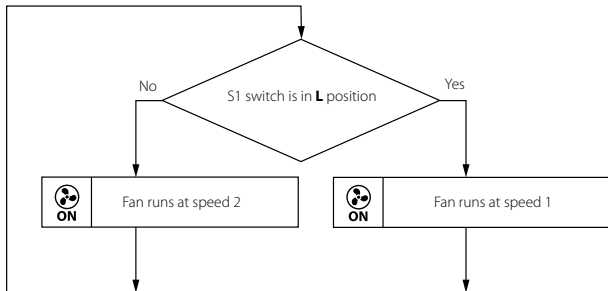
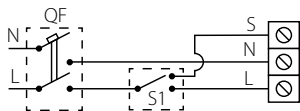

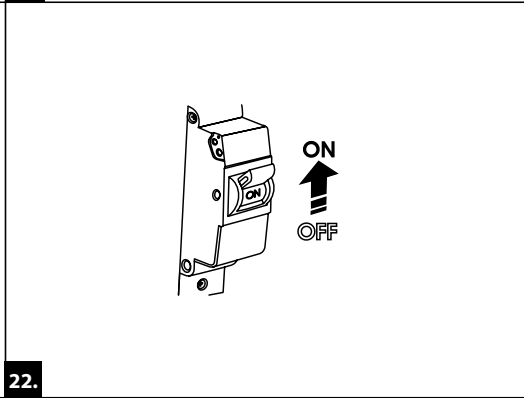
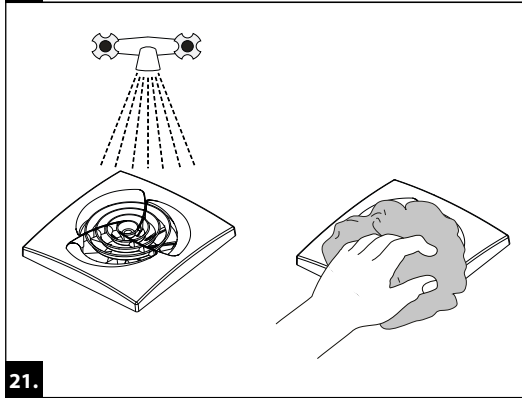
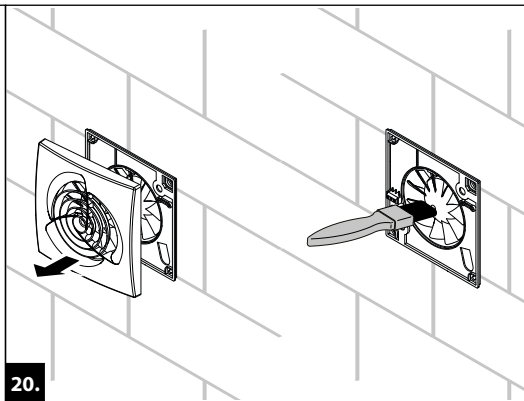
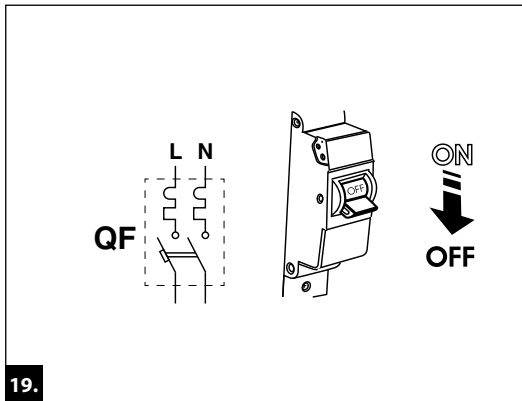

Quality Inspector's Stamp

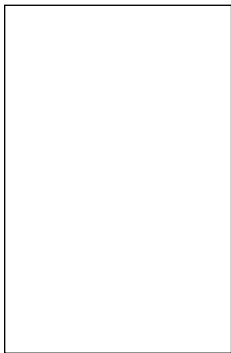

Sold by
(name and stamp of the seller)



Manufacture Date

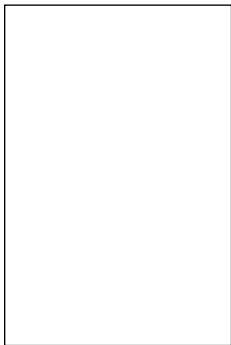

Purchase Date



Trio _____

