

Axis-QR EC

Axial wall fans

Use

- Supply and extract ventilation systems installed in various premises.
- Ideal solution for boosting large air volumes at low aerodynamic resistance in the ventilation system.
- Refrigerating technologies for cooling of compressor condensing units.
- Direct air extract.
- For positive pressure ventilation in fire-fighting systems.



Air flow:
up to 8500 m³/h
2361 l/s



Design

- Steel casing and impeller with a special polymer atmospheric resistant coating.
- Casing is equipped with a round mounting plate and a round flange to facilitate wall mounting.
- The fan is equipped with a terminal box for connection to power mains.

Motor

- Energy efficient EC motor.
- 220–240 V single phase at 50 (60) Hz.
- Equipped with ball bearings for longer service life (up to 40 000 hours).
- All motors have thermal overload protection.

Speed control

- The fan speed is regulated by a smooth 0-10 V controller.

Mounting

- Wall surface mounting with a round connecting frame.
- Installation is carried out according to the user's manual in accordance with the direction of air flow.
- Power is supplied through an external terminal box.

AXIAL FANS

Designation key

Series	Motor type	Dimension type	Motor modifications
Axis-QR	EC: electronically commutated motor	200; 250; 300; 350; 400; 450; 500	max: high-powered motor

Accessories

Speed controllers



CDT E/0-10

Overall dimensions [mm]

Type	∅ D	∅ D1	∅ D2	∅ d	L	L1	Mounting hole diameter	Weight [kg]
Axis-QR EC 200	210	250	280	7	81	93	210	1,6
Axis-QR EC 200 max	210	250	280	7	81	93	210	1,7
Axis-QR EC 250	262	318	340	7	81	93	260	2
Axis-QR EC 250 max	262	318	340	7	81	93	260	2
Axis-QR EC 300	317	380	397	9	104	116	317	2,7
Axis-QR EC 300 max	317	380	397	9	104	116	317	2,8
Axis-QR EC 350	374	442	460	9	97	157	374	3,8
Axis-QR EC 400	416	504	528	9	97	157	417	4,6
Axis-QR EC 450	470	578	607	11	176	294	465	6,3
Axis-QR EC 500	520	590	655	11	180	294	520	7

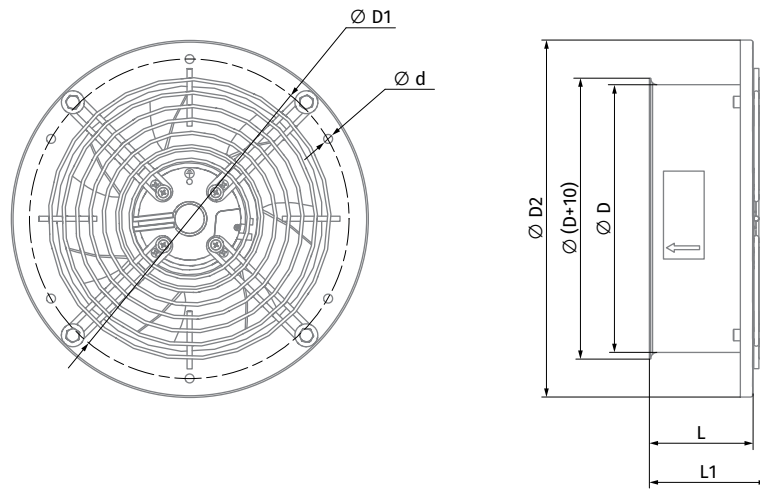

Technical data

Parameters	Axis-QR EC 200	Axis-QR EC 200 max	Axis-QR EC 250	Axis-QR EC 250 max	Axis-QR EC 300	Axis-QR EC 300 max
Voltage [V]	1 ~ 230	1 ~ 230	1 ~ 230	1 ~ 230	1 ~ 230	1 ~ 230
Frequency [Hz]	50/60	50/60	50/60	50/60	50/60	50/60
Power [W]	55	115	85	115	150	210
Current [A]	0,4	0,85	0,61	0,85	1,2	1,5
Maximum air flow [m ³ /h (l/s)]	975 (271)	1600 (444)	1550 (431)	1850 (514)	2400 (667)	2750 (764)
RPM [min ⁻¹]	2780	2900	2480	2950	2000	2200
Sound pressure at 3 m [dBA]	50	54	50	57	57	57
Transported air temperature [°C]	-25...+60	-25...+60	-25...+60	-25...+60	-25...+60	-25...+60
IP rating	IPX5	IPX5	IPX5	IPX5	IPX5	IPX5
Motor IP rating	IP55	IP55	IP55	IP55	IP55	IP55

AXIS-QR EC 200, AXIS-QR EC 200 MAX

Sound power level, A-weighted	Total	Octave frequency bands [Hz]								LpA 3 m	LpA 1 m
		63	125	250	500	1000	2000	4000	8000		
Axis-QR EC 200											
LWA to environment [dBA]	70	55	67	66	60	58	50	37	31	50	60
Axis-QR EC 200 max											
LWA to environment [dBA]	75	60	72	70	63	61	52	39	33	54	64

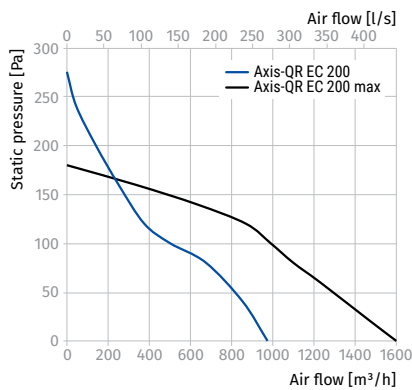
AXIS-QR EC 250, AXIS-QR EC 250 MAX

Sound power level, A-weighted	Total	Octave frequency bands [Hz]								LpA 3 m	LpA 1 m
		63	125	250	500	1000	2000	4000	8000		
Axis-QR EC 250											
LWA to environment [dBA]	71	56	68	66	60	58	50	37	31	50	60
Axis-QR EC 250 max											
LWA to environment [dBA]	77	62	75	72	65	63	54	40	34	57	67

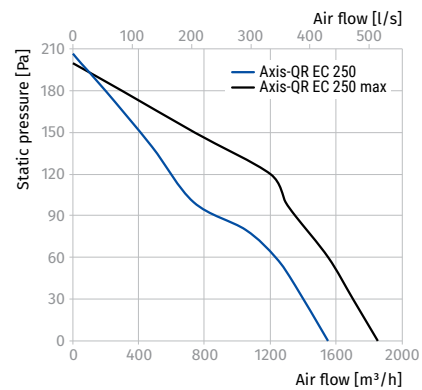
AXIS-QR EC 300, AXIS-QR EC 300 MAX

Sound power level, A-weighted	Total	Octave frequency bands [Hz]								LpA 3 m	LpA 1 m
		63	125	250	500	1000	2000	4000	8000		
Axis-QR EC 300											
LWA to environment [dBA]	78	63	75	73	66	63	54	41	34	57	67
Axis-QR EC 300 max											
LWA to environment [dBA]	78	63	76	73	66	63	54	41	34	57	67

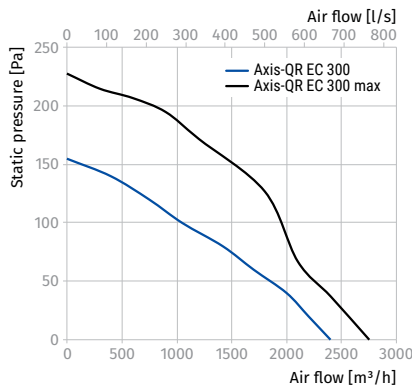

Parameters	Axis-QR EC 350	Axis-QR EC 400	Axis-QR EC 450	Axis-QR EC 500
Voltage [V]	1 ~ 230	1 ~ 230	1 ~ 230	1 ~ 230
Frequency [Hz]	50/60	50/60	50/60	50/60
Power [W]	200	170	380	700
Current [A]	1,4	1,3	1,7	3,1
Maximum air flow [m³/h (l/s)]	3500 (972)	4000 (1111)	7400 (2056)	8500 (2361)
RPM [min ⁻¹]	1670	1180	1400	1600
Sound pressure at 3 m [dBA]	58	58	65	70
Transported air temperature [°C]	-25...+60	-25...+60	-25...+60	-25...+60
IP rating	IPX5	IPX5	IPX5	IPX5
Motor IP rating	IP55	IP55	IP55	IP55

AXIS-QR EC 350

Sound power level, A-weighted	Total	Octave frequency bands [Hz]								LpA 3 m	LpA 1 m
		63	125	250	500	1000	2000	4000	8000		
LWA to environment [dBA]	78	63	76	73	66	64	54	41	34	58	68

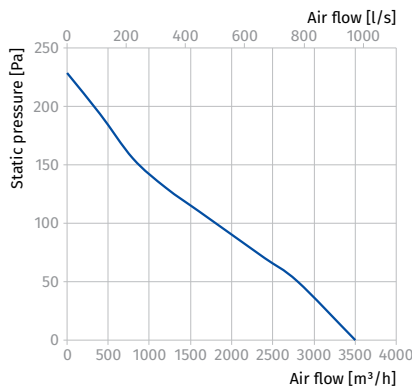

AXIS-QR EC 400

Sound power level, A-weighted	Total	Octave frequency bands [Hz]								LpA 3 m	LpA 1 m
		63	125	250	500	1000	2000	4000	8000		
LWA to environment [dBA]	79	64	76	73	66	64	55	41	34	58	68

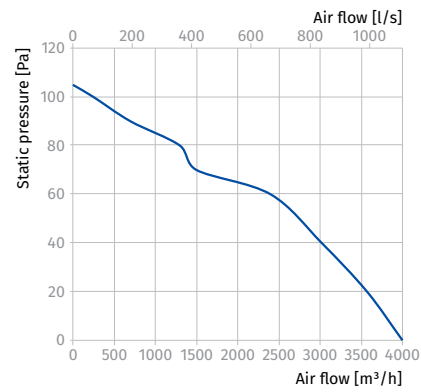

AXIS-QR EC 450

Sound power level, A-weighted	Total	Octave frequency bands [Hz]								LpA 3 m	LpA 1 m
		63	125	250	500	1000	2000	4000	8000		
LWA to environment [dBA]	86	71	84	80	72	69	59	44	37	65	75

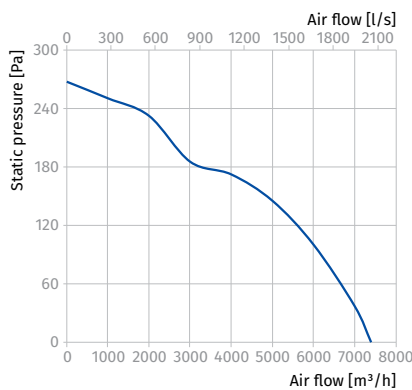

AXIS-QR EC 500

Sound power level, A-weighted	Total	Octave frequency bands [Hz]								LpA 3 m	LpA 1 m
		63	125	250	500	1000	2000	4000	8000		
LWA to environment [dBA]	91	77	89	85	76	73	62	47	39	70	80

