

BLAUBOX EC ME

Supply ventilation units

Features

- Ventilation unit for efficient supply ventilation in various premises.
- Controllable air supply, heating and filtration.
- BMS connection via ModBUS RTU.



Air flow:
up to 5000 m³/h
1389 l/s

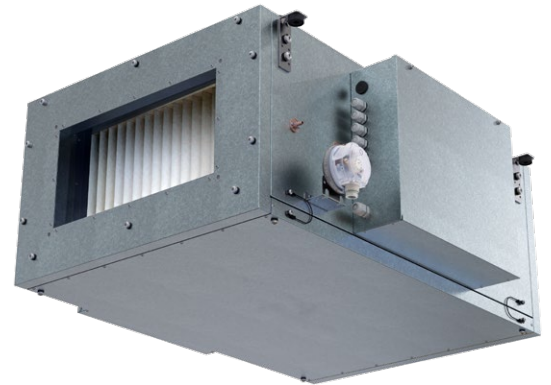

Design

- Steel casing covered with aluzinc coating internally filled with 30 mm heat- and sound-insulating layer made of mineral wool.
- Mounting brackets with anti-vibration rubber. Service panel ensures easy access to the internals.
- **Blaubox EC ME 300 ... 700** are compatible with round ducts.

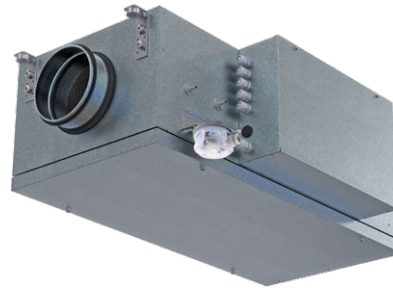

Blaubox EC ME 300 ... 700

Blaubox EC ME 300 ... 700

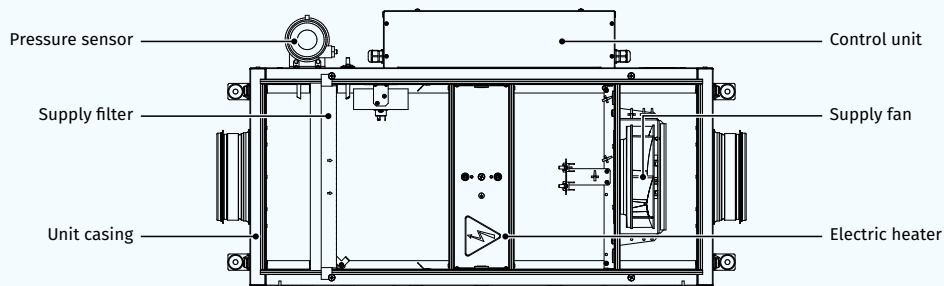

Blaubox EC ME 1000 ... 4000

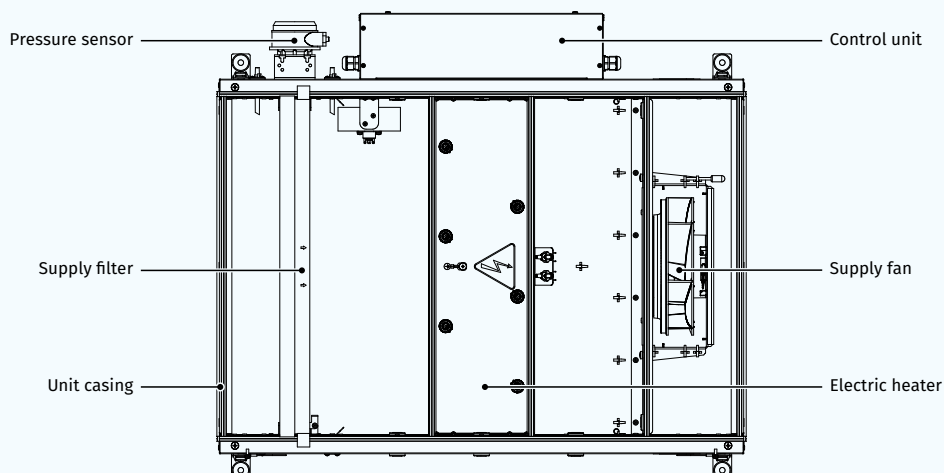

Fans

- o Efficient external rotor EC-motors and centrifugal impellers with backward curved blades.
- o EC-motors are featured with high performance, low noise level and totally controllable speed range.
- o Dynamically balanced impeller.

Air filtration

- o Panel Coarse 90% (G4) filter for supply air purification.
- o Panel ePM10 70% (F7) filter is available as an option.

Air heater

- o The unit is equipped with an electric heater.
- o Heating elements are extra ribbed for larger heat exchange surface.
- o Integrated overheat protection.



Mounting

- o The unit is suitable for indoor mounting on the floor, ceiling mounting or wall mounting with fixing brackets in any mounting position, except for the vertical one with air flow downward.
- o The correctly mounted unit must provide free access to the service panel.

Control and automation

- o The units are equipped with an S31 integrated automation control system.
- o Remote control panels are not included in the delivery set and ordered separately.

Automation functions

Functions	Description
Wired control panel	S30 
Wired control panel	S32 
Unit on / off	+
Fan speed control and setting	+
Filter clogging indication and control	Pressure sensor
Week schedule	+
Electric heater protection with auto restart	+
Electric heater protection with manual restart	+
Supply temperature control	+
Outer temperature sensor	+
Water heater frost protection	+
Return temperature sensor	+
Air damper control	+
Alarm indication	+
BMS Connection	ModBUS (RTU)
Humidity sensor	0-10 V or NO
CO ₂ Sensor	0-10 V or NO
Exhaust fan control	on / off
Three-way valve control	+
Circulation pump control	+
Condensing unit control	0-10 V

Designation key

Series	Motor type	Heater type	Rated air flow [m³/h]	Electric heater power [kW]	Service side	Control
Blaubox: supply air unit	EC: electronically commutated motor	ME: electric	300; 400; 700; 1000; 1500; 2000; 3000; 4000	1.7; 2.0; 3.0; 5.1; 6.0; 9.0; 12.0; 14.0; 15.0; 18.0; 27.0; 45.0; 54.0	L: left R: right	S31

Overall dimensions [mm]

Model	∅ D	H	H1	L	L1	L2	W	W1	W2	W3
Blaubox EC ME 300 S31	160	290	-	850	903	950	400	514	313	-
Blaubox EC ME 400 S31	200	350	-	850	903	972	400	514	313	-
Blaubox EC ME 700 S31	250	350	-	850	903	972	460	565	353	-
Blaubox EC ME 1000 S31	-	380	200	900	770	-	600	653	746	400
Blaubox EC ME 1500 S31	-	440	250	900	770	-	700	754	847	500
Blaubox EC ME 2000 S31	-	440	300	900	770	-	700	754	847	500
Blaubox EC ME 3000 S31	-	500	300	1200	1070	-	800	853	944	600
Blaubox EC ME 4000 S31	-	550	400	1200	1070	-	940	993	1087	700

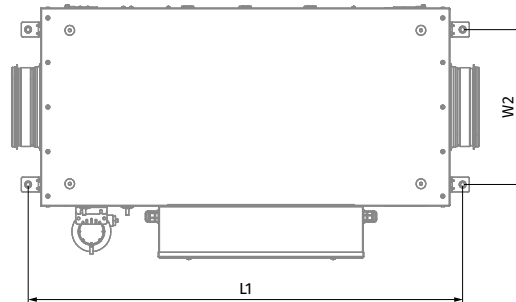
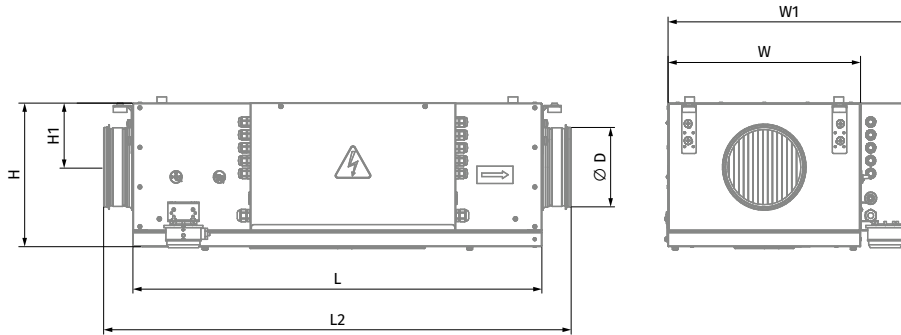

Blaubox EC ME 300 – Blaubox EC ME 700

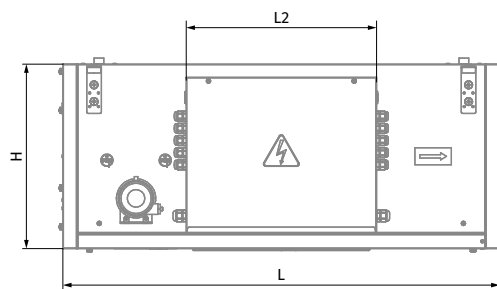
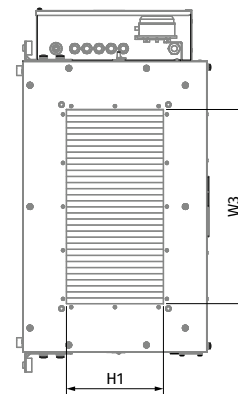
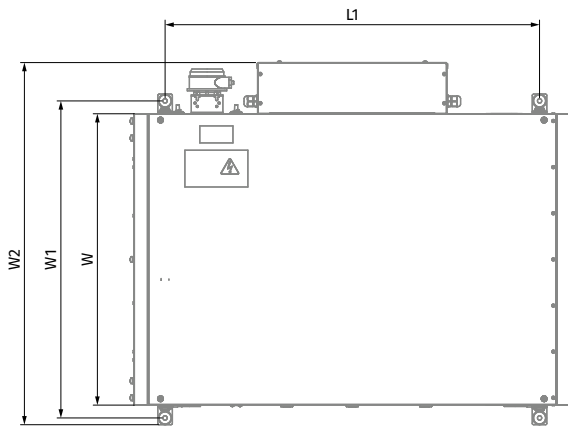

Blaubox EC ME 1000 – Blaubox EC ME 4000

Technical data

Parameters	Blaubox EC ME 300-1.7 S31	Blaubox EC ME 300-5.1 S31	Blaubox EC ME 400-2.4 S31	Blaubox EC ME 400-3.3 S31	Blaubox EC ME 400-6 S31
Supply voltage [V / 50 Hz]	1 ~ 230	3 ~ 400	1 ~ 230	3 ~ 400	3 ~ 400
Max. unit power without electric heater [kW]	0.064	0.064	0.062	0.062	0.062
Electric heater power [kW]	1.7	5.1	2.4	3.3	6.0
Max. power with electric heater [kW]	1.764	5.164	2.462	3.362	6.062
Max. unit current without electric heater [A]	0.3	0.3	0.5	0.5	0.5
Max. current with electric heater [A]	7.7	7.4	12	5.4	9.7
Maximum airflow [m³/h]	365	354	430	430	430
Sound pressure level at 3 m [dBA]	35	35	31	31	31
Transported air temperature [°C]	-30...+40	-30...+40	-30...+40	-30...+40	-30...+40
Casing material	aluzinc	aluzinc	aluzinc	aluzinc	aluzinc
Insulation	30 mm mineral wool	30 mm mineral wool	30 mm mineral wool	30 mm mineral wool	30 mm mineral wool
Filter	Coarse 90% / G4 (option: ePM1 70% / F7)	Coarse 90% / G4 (option: ePM1 70% / F7)	Coarse 90% / G4 (option: ePM1 70% / F7)	Coarse 90% / G4 (option: ePM1 70% / F7)	Coarse 90% / G4 (option: ePM1 70% / F7)
Connected air duct diameter [mm]	160	160	200	200	200
Weight [kg]	24	24	25	25	25

BLAUBOX EC ME 300 S31

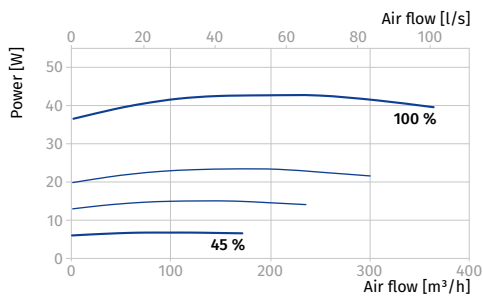
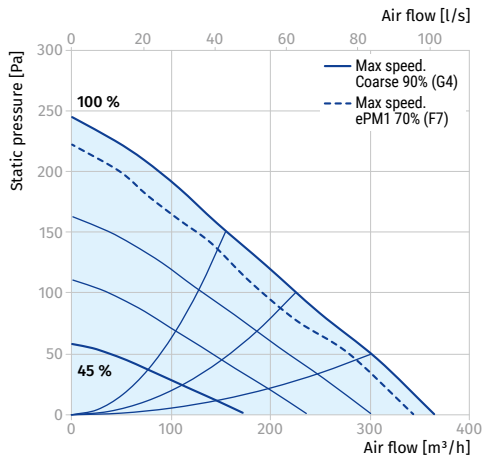

BLAUBOX EC ME 400 S31

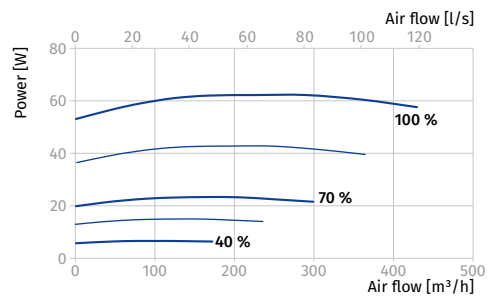
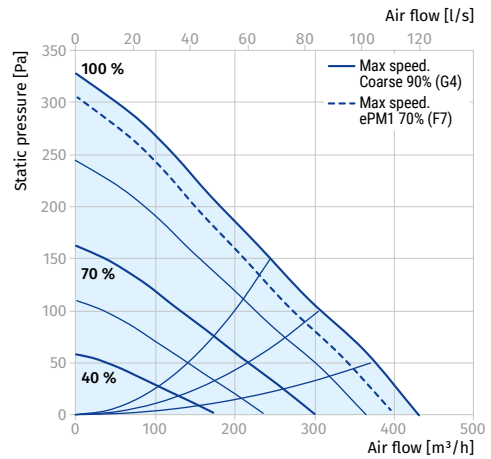

Parameters	Blaubox EC ME 700-3 S31	Blaubox EC ME 700-6 S31	Blaubox EC ME 700-9 S31	Blaubox EC ME 1000-6 S31	Blaubox EC ME 1000-12 S31	Blaubox EC ME 1000-15 S31
Supply voltage [V / 50 Hz]	3 ~ 400	3 ~ 400	3 ~ 400	3 ~ 400	3 ~ 400	3 ~ 400
Max. unit power without electric heater [kW]	0.116	0.116	0.116	0.165	0.165	0.165
Electric heater power [kW]	3.0	6.0	9.0	6.0	12.0	15.0
Max. power with electric heater [kW]	3.116	6.116	9.116	6.165	12.165	15.165
Max. unit current without electric heater [A]	0.5	0.5	0.5	1.3	1.3	1.3
Max. current with electric heater [A]	5	10	14.6	11	19.5	24.3
Maximum airflow [m³/h]	760	760	760	1000	1000	1000
Sound pressure level at 3 m [dBA]	41	41	41	45	45	45
Transported air temperature [°C]	-30...+40	-30...+40	-30...+40	-30...+40	-30...+40	-30...+40
Casing material	aluzinc	aluzinc	aluzinc	aluzinc	aluzinc	aluzinc
Insulation	30 mm mineral wool	30 mm mineral wool	30 mm mineral wool	30 mm mineral wool	30 mm mineral wool	30 mm mineral wool
Filter	Coarse 90% / G4 (option: ePM1 70% / F7)	Coarse 90% / G4 (option: ePM1 70% / F7)	Coarse 90% / G4 (option: ePM1 70% / F7)	Coarse 90% / G4 (option: ePM1 70% / F7)	Coarse 90% / G4 (option: ePM1 70% / F7)	Coarse 90% / G4 (option: ePM1 70% / F7)
Connected air duct diameter [mm]	250	250	250	400 × 200	400 × 200	400 × 200
Weight [kg]	27	27	27	30	30	30

BLAUBOX EC ME 700 S31

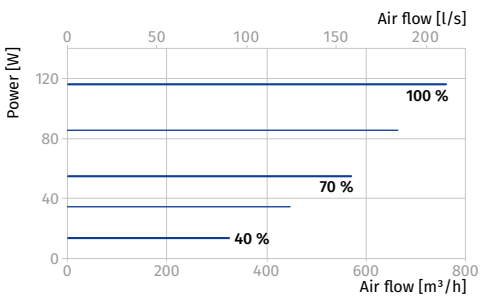
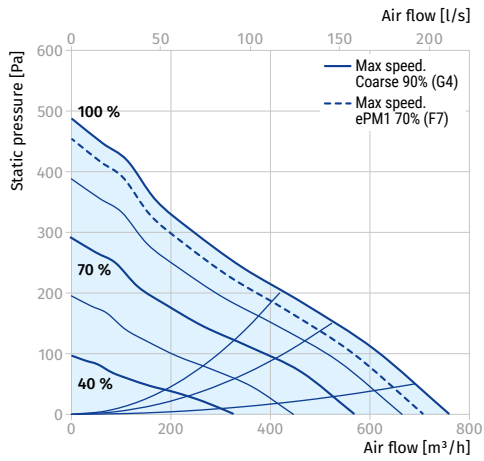

BLAUBOX EC ME 1000 S31

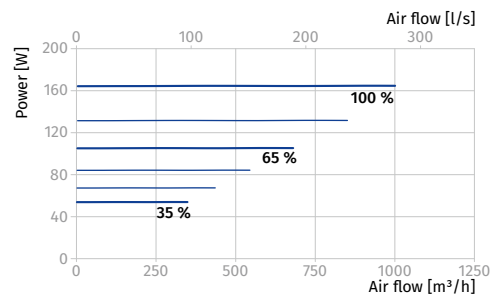
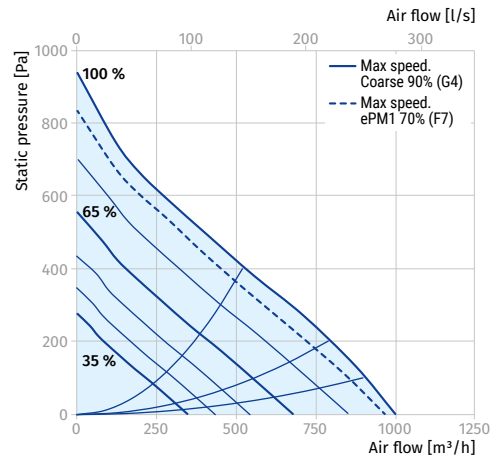

Parameters	Blaubox EC ME 1500-9 S31	Blaubox EC ME 1500-15 S31	Blaubox EC ME 1500-18 S31	Blaubox EC ME 2000-12 S31	Blaubox EC ME 2000-18 S31	Blaubox EC ME 2000-24 S31
Supply voltage [V / 50 Hz]	3 ~ 400	3 ~ 400	3 ~ 400	3 ~ 400	3 ~ 400	3 ~ 400
Max. unit power without electric heater [kW]	0.223	0.223	0.223	0.406	0.406	0.406
Electric heater power [kW]	9.0	15.0	18.0	12.0	18.0	24.0
Max. power with electric heater [kW]	9.223	15.223	18.223	12.406	18.406	24.406
Max. unit current without electric heater [A]	1.7	1.7	1.7	1.8	1.8	1.8
Max. current with electric heater [A]	14.8	22.8	29.2	19.9	29.5	39.1
Maximum airflow [m³/h]	1500	1500	1500	2450	2450	2450
Sound pressure level at 3 m [dBA]	46	46	46	48	48	48
Transported air temperature [°C]	-30...+40	-30...+40	-30...+40	-30...+40	-30...+40	-30...+40
Casing material	aluzinc	aluzinc	aluzinc	aluzinc	aluzinc	aluzinc
Insulation	30 mm mineral wool	30 mm mineral wool	30 mm mineral wool	30 mm mineral wool	30 mm mineral wool	30 mm mineral wool
Filter	Coarse 90% / G4 (option: ePM1 70% / F7)	Coarse 90% / G4 (option: ePM1 70% / F7)	Coarse 90% / G4 (option: ePM1 70% / F7)	Coarse 90% / G4 (option: ePM1 70% / F7)	Coarse 90% / G4 (option: ePM1 70% / F7)	Coarse 90% / G4 (option: ePM1 70% / F7)
Connected air duct diameter [mm]	500 × 250	500 × 250	500 × 250	500 × 300	500 × 300	500 × 300
Weight [kg]	35	35	35	40	40	40

BLAUBOX EC ME 1500 S31

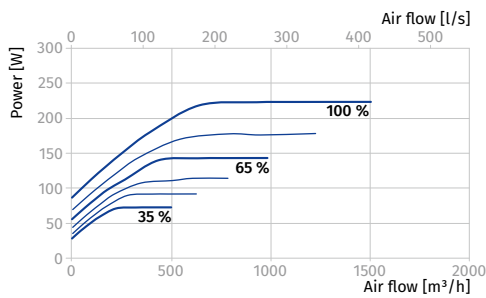
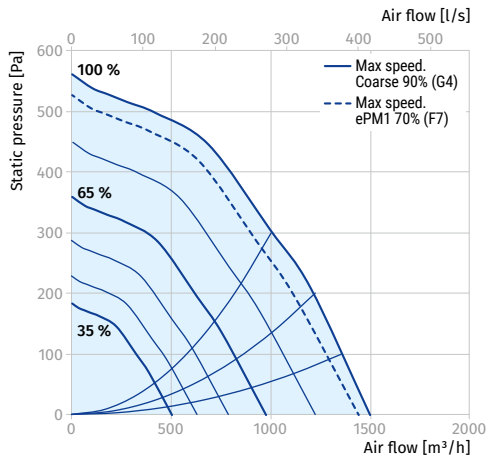

BLAUBOX EC ME 2000 S31

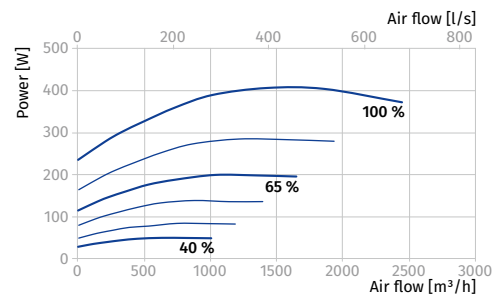
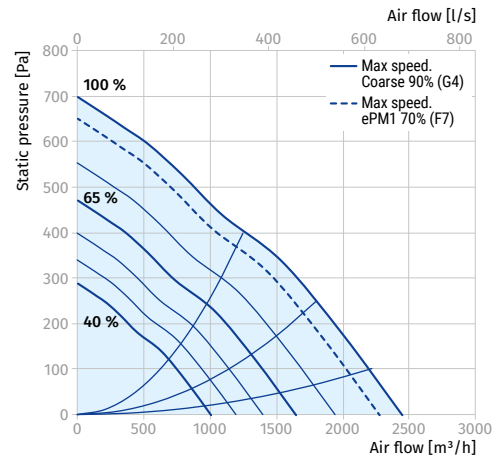

Parameters	Blaubox EC ME 3000-18 S31	Blaubox EC ME 3000-27 S32	Blaubox EC ME 3000-45 S33	Blaubox EC ME 4000-24 S34	Blaubox EC ME 4000-45 S35	Blaubox EC ME 4000-54 S36
Supply voltage [V / 50 Hz]	3 ~ 400	3 ~ 400	3 ~ 400	3 ~ 400	3 ~ 400	3 ~ 400
Max. unit power without electric heater [kW]	0.472	0.472	0.472	0.717	0.717	0.717
Electric heater power [kW]	18.0	27.0	45.0	24.0	45.0	54.0
Max. power with electric heater [kW]	18.472	27.472	45.472	24.717	45.717	54.717
Max. unit current without electric heater [A]	2.1	2.1	2.1	1.1	1.1	1.1
Max. current with electric heater [A]	29.6	44	72.8	42.9	73.2	87.6
Maximum airflow [m³/h]	3150	3150	3150	5000	5000	5000
Sound pressure level at 3 m [dBA]	47	47	47	49	49	49
Transported air temperature [°C]	-30...+40	-30...+40	-30...+40	-30...+40	-30...+40	-30...+40
Casing material	aluzinc	aluzinc	aluzinc	aluzinc	aluzinc	aluzinc
Insulation	30 mm mineral wool	30 mm mineral wool	30 mm mineral wool	30 mm mineral wool	30 mm mineral wool	30 mm mineral wool
Filter	Coarse 90% / G4 (option: ePM1 70% / F7)	Coarse 90% / G4 (option: ePM1 70% / F7)	Coarse 90% / G4 (option: ePM1 70% / F7)	Coarse 90% / G4 (option: ePM1 70% / F7)	Coarse 90% / G4 (option: ePM1 70% / F7)	Coarse 90% / G4 (option: ePM1 70% / F7)
Connected air duct diameter [mm]	600 × 300	600 × 300	600 × 300	700 × 400	700 × 400	700 × 400
Weight [kg]	50	50	50	60	60	60

BLAUBOX EC ME 3000 S31

BLAUBOX EC ME 4000 S31

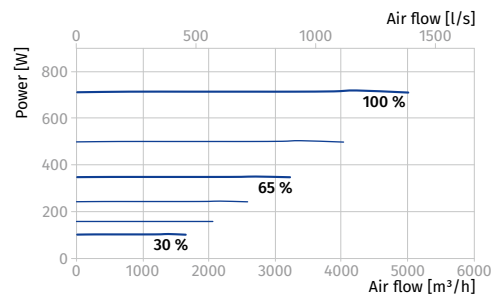
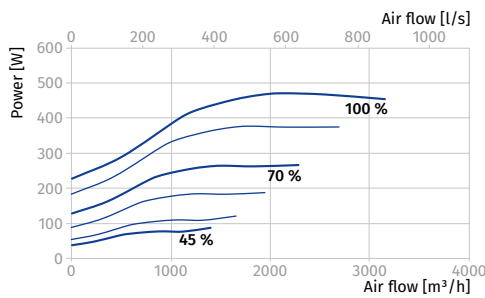
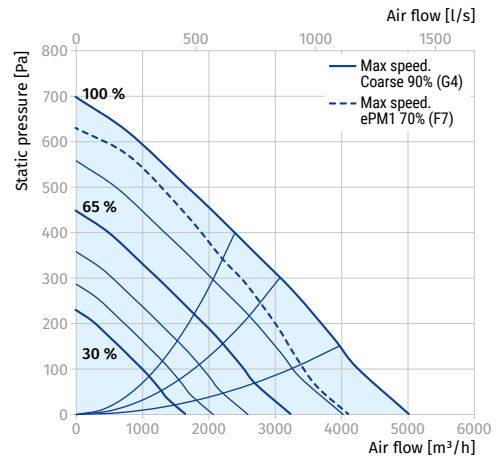
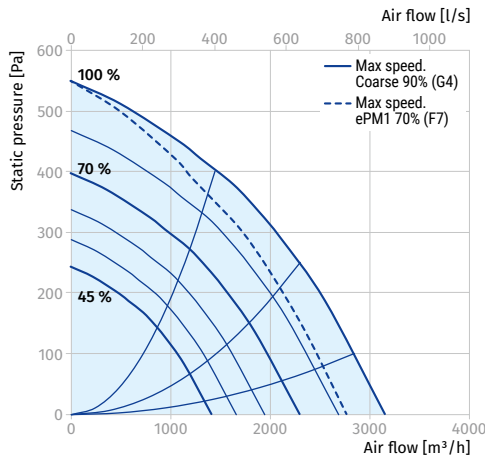

SUPPLY VENTILATION UNITS

Accessories

		Blaubox EC ME 300	Blaubox EC ME 400	Blaubox EC ME 700	Blaubox EC ME 1000
Panel filter G4		FP 334x226x48 Coarse 90% / G4	FP 334x287x48 Coarse 90% / G4	FP 384x287x48 Coarse 90% / G4	FP 536x316x48 Coarse 90% / G4
Panel filter F7		FP 334x226x48 ePM1 70% / F7	FP 334x287x48 ePM1 70% / F7	FP 384x287x48 ePM1 70% / F7	FP 536x316x48 ePM1 70% / F7
Flexible anti-vibration connector		EVA 125	EVA 200	EVA 250	EVA 40x20
Silencer		SD 125	SD 200	SD 250	SD 40x20
Air damper		VKA 125	VKA 200	VKA 250	SL 40x20
Air damper electric actuator		TF230 / TF24	TF230 / TF24	TF230 / TF24	TF230 / TF24

		Blaubox EC ME 1500	Blaubox EC ME 2000	Blaubox EC ME 3000	Blaubox EC ME 4000
Panel filter G4		FP 636x376x48 Coarse 90% / G4	FP 636x376x48 Coarse 90% / G4	FP 734x435x80 Coarse 90% / G4	FP 874x485x80 Coarse 90% / G4
Panel filter F7		FP 636x376x48 ePM1 70% / F7	FP 636x376x48 ePM1 70% / F7	FP 384x287x48 ePM1 70% / F7	FP 874x485x80 ePM1 70% / F7
Flexible anti-vibration connector		EVA 50x25	EVA 50x30	EVA 60x30	EVA 70x40
Silencer		SD 50x25	SD 50x30	SD 60x30	SD 70x40
Air damper		SL 50x25	SL 50x30	SL 60x30	SL 70x40
Air damper electric actuator		TF230 / TF24	TF230 / TF24	TF230 / TF24	TF230 / TF24