

inWave

Sound-insulated inline mixed-flow fans

Use

- Supply and extract ventilation systems installed in various premises with high requirements to the noise level.
- For ventilation air ducts requiring high pressure, powerful air flow and low noise level.
- Compatible with Ø 100, 125, 150 and 160 mm air ducts.



Air flow:
up to 540 m³/h
150 l/s



Power:
from 32 W



Noise level:
from 19 dBA



Design

- The casing is made of high-quality durable plastic, internally filled with 50 mm mineral wool thermal- and sound-insulating layer.
- Special inner perforation of the casing and sound-insulating material are designed for wide-frequency sound absorbing.
- Mixed-flow impeller made of high-quality plastic.
- The diffusor, the specially profiled impeller and directing vanes provide high performance and powerful pressure combined with low noise operation.
- External airtight terminal block on the fan casing for power supply.
- Mounting brackets on the fan casing for mounting to the floor, to the wall or ceiling.

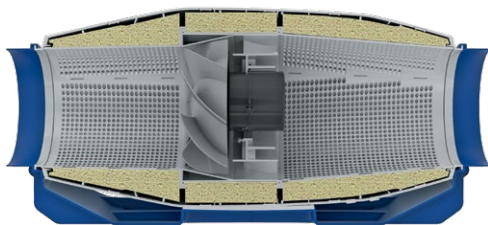

Motor

- Single-phase high-efficient motor with low energy demand on ball bearings.
- Overheating protection due to built-in thermal switches.
- Motor ingress protection rating IPX4.

Speed control

- Speed selection with a built-in speed switch (US option) or an external multi-speed controller (specially ordered accessory).
- Smooth speed control is possible either with an integrated speed controller (**FR1** option), an external thyristor or transformer speed controller (specially ordered accessory) when connected to the maximum speed terminal.

Mounting







- Due to its compact design the fan is the ideal solution for mounting in limited spaces.
- The fan is suitable for mounting in any section of the ventilation system from intake to the end of the ductwork.
- Wall or ceiling mounting with a special bracket on the fan casing.

SOUND-INSULATED INLINE FANS

Designation key

Series	Duct diameter [mm]	Options
inWave	100/125; 150/160	T: turn-off delay timer adjustable from 2 to 30 minutes US: three-position speed switch FR1: smooth speed controller adjustable from 0 to 100 % and power cable with mains plug G1: speed controller, temperature controller with external temperature sensor, power cable with mains plug W1: power cable with mains plug

Accessories

Silencers	Filter boxes	Electric heaters	Water heaters	Backdraft air dampers	Air dampers	Clamps	Temperature controllers	Speed controllers	Timers/Sensors
									
SD	KFBK / KFBT	EKH	WKH	VRV	VK / VKA	K	MLCD E2	CDP / CDT	TE(TI) / HSE(HSI) / LSE(LSI) / IRSE(IRSI)

Modifications and options

- o **T:** turn-off delay timer adjustable from 2 to 30 minutes.
- o **US:** three-position speed switch.
- o **FR1:** smooth speed controller adjustable from 0 to 100 % and power cable with mains plug.



- o **G1:** speed controller, temperature controller with external temperature sensor (cable length 4 m), power cable with mains plug.
- o The **G1** modification enables automatic speed control depending on indoor temperature. The optimal ventilation solution for premises requiring permanent temperature control as greenhouses, orangeries, etc.
- o **W1:** power cable with mains plug.

Overall dimensions [mm]

Type	Ø D	H	L	W	Weight [kg]
inWave 100/125 (spigot 100 mm)	99	273	752	253	5.0
inWave 100/125 (spigot 125 mm)	124	273	679	253	5.0
inWave 150/160 (spigot 150 mm)	149	273	606	253	5.0
inWave 150/160 (spigot 160 mm)	149	273	606	253	5.0

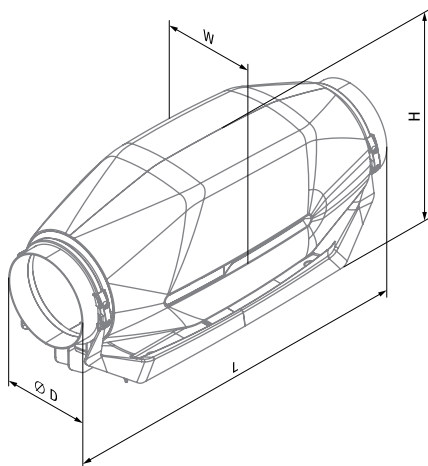

inWave 100/125 (spigot 100 mm)



inWave 100/125 (spigot 125 mm)



inWave 150/160 (spigot 150 mm, spigot 160 mm with a rubber seal)

Technical data

Parameters	inWave 100/125			inWave 100/125			inWave 150/160		
	min	mid	max	min	mid	max	min	mid	max
Spigot	100			125			150/160		
Speed	min	mid	max	min	mid	max	min	mid	max
Voltage [V]	1~ 230			1~ 230			1~ 230		
Frequency [Hz]	50			50			50		
Power [W]	28	31	32	31	33	34	25	46	51
Current [A]	0.13	0.14	0.15	0.14	0.14	0.16	0.20	0.21	0.24
Maximum air flow [m³/h (l/s)]	114 (32)	147 (41)	220 (61)	164 (46)	216 (60)	320 (89)	242 (67)	320 (89)	540 (150)
RPM [min ⁻¹]	1568	1952	2362	1552	1952	2356	1982	2374	2738
Sound pressure at 3 m [dBA]	19	23	27	20	22	28	20	26	33
Max. transported air temperature [°C]	-25...+55			-25...+55			-25...+55		
IP rating	IPX4			IPX4			IPX4		
Motor IP rating	IP20			IP20			IP20		
ErP	2018			2018			2018		

To comply with ErP 2018 it is necessary to use a speed controller and local demand control typology (connect the sensor).

INWAVE 100/125 (SPIGOT 100 MM)

Sound power level, A-weighted	Total	Octave frequency bands [Hz]								LpA 3 m	LpA 1 m
		63	125	250	500	1000	2000	4000	8000		
L _{WA} to inlet [dBA]	52	28	46	50	41	35	33	36	29	32	42
L _{WA} to outlet [dBA]	51	25	43	50	40	32	31	36	31	31	41
L _{WA} to environment [dBA]	48	28	44	44	36	32	28	27	22	27	37

INWAVE 100/125 (SPIGOT 125 MM)

Sound power level, A-weighted	Total	Octave frequency bands [Hz]								LpA 3 m	LpA 1 m
		63	125	250	500	1000	2000	4000	8000		
L _{WA} to inlet [dBA]	54	31	49	52	43	37	34	37	30	34	44
L _{WA} to outlet [dBA]	52	26	44	51	41	33	32	37	31	32	42
L _{WA} to environment [dBA]	48	28	45	45	37	32	28	28	22	28	38

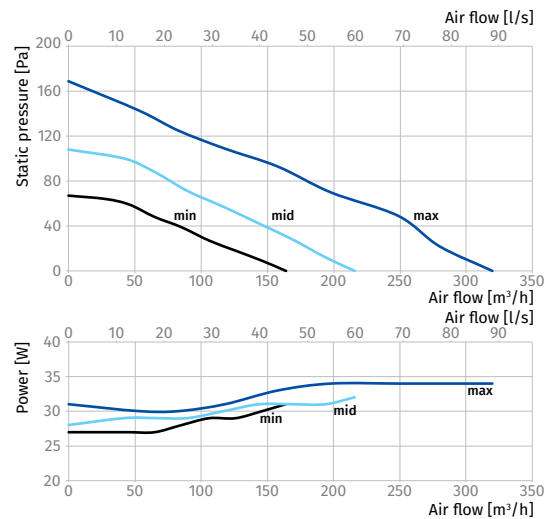
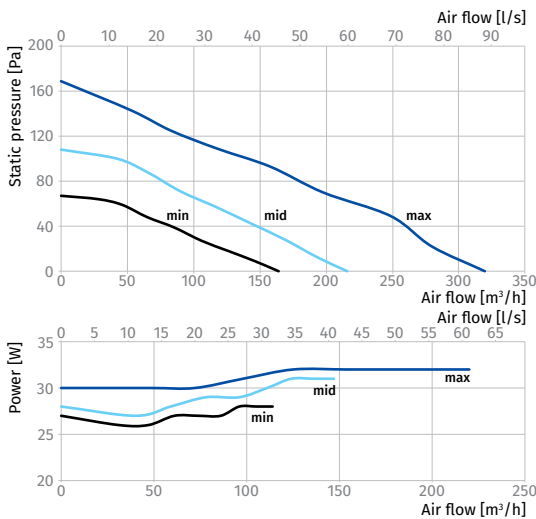

INWAVE 150/160

Sound power level, A-weighted	Total	Octave frequency bands [Hz]								LpA 3 m	LpA 1 m
		63	125	250	500	1000	2000	4000	8000		
L _{WA} to inlet [dBA]	61	37	56	59	48	41	38	41	34	41	51
L _{WA} to outlet [dBA]	60	32	52	58	47	37	36	41	35	39	49
L _{WA} to environment [dBA]	53	33	50	49	40	35	30	30	24	33	43

