

Primo EC

Inline mixed flow fans with EC motors

Use

- Inline fans for supply and exhaust ventilation of various commercial and industrial premises requiring powerful air flow.
- The fans are compatible with Ø 200, 315, 355 and 400 mm air ducts.
- Combines wide capabilities and high performance features of axial and centrifugal fans, providing powerful air flow.



Air flow:
up to 5700 m³/h
1583 l/s



Power:
from 121 W



Noise level:
from 33 dBA



Design

- The casing is made of polymer (for models 315, 355 and 400 the casing is additionally reinforced with a metal housing).
- Due to the conically shaped polymer impeller with specially profiled blades, the air stream circular velocity increases, which results in higher air flow and pressure, as compared to characteristics of standard axial fans.
- The specially designed diffuser, impeller and airflow rectifier at the fan outlet provide smooth air flow distribution and enable the best combination of high capacity, powerful pressure and low noise.
- The fan casing is equipped with an airtight terminal box for connection to power mains.

Motor

- Energy efficient EC motor.
- 220–240 V single phase at 50 Hz.
- Equipped with ball bearings for longer service life (up to 40 000 hours).
- All motors have manual reset thermal overload protection.

Speed control

- The fan speed is regulated by a smooth 0-10 V controller.

Mounting

- The fans can be mounted at any place and at any angle within the ductwork system. Several fans may be installed in one system in parallel to attain higher air capacity or in series to increase operating pressure in the system. The fan casing is equipped with fixing brackets for suspended mounting.
- The fans can be installed using the appropriately sized **UM Primo** bracket (ordered separately, available for models 315, 355 and 400).



Primo EC 200



Primo EC 315 max, 355 (max), 400

Overall dimensions [mm]

Model	Ø D	Ø D1	H	H1	L	W
Primo EC 200	198.5	–	308	–	302	293
Primo EC 315 max	315	406	408	439	372	566
Primo EC 355 (max)	355	406	408	439	372	566
Primo EC 400	400	451	453	484	415	623

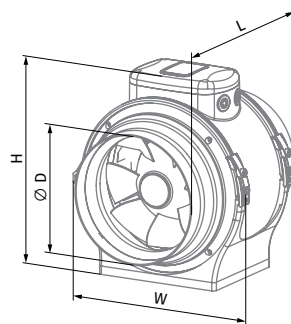

Primo EC 200

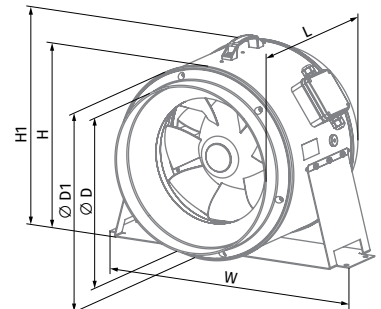

Primo EC 315 max, 355 (max), 400

Designation key

Series	Motor type	Duct diameter [mm]	Motor modifications	Modifications
Primo	EC: electronically commutated motor	200; 315; 355; 400	max: high-powered motor	FR1: smooth speed controller adjustable from 0 to 100 % and power cable with mains plug G1: speed controller, temperature controller with external temperature sensor, power cable with mains plug W1: power cable with mains plug

Technical data

Parameters	Primo EC 200	Primo EC 315 max
Voltage [V]	1~ 220-240	1~ 230
Frequency [Hz]	50/60	50
Power [W]	121	353
Current [A]	0.96	1.56
Maximum air flow [m³/h (l/s)]	1250 (347)	3250 (903)
RPM [min⁻¹]	3100	2424
Sound pressure at 3 m [dBA]	50	55
Transported air temperature [°C]	-25...+55	-25...+55
Protection rating	IPX4	IPX4
Motor protection rating	IP44	IP44
Erp compliance	2018	2018

PRIMO EC 200

Sound power level, A-weighted	Total	Octave frequency bands [Hz]								LpA 3 m	LpA 1 m
		63	125	250	500	1000	2000	4000	8000		
LWA to inlet [dBA]	78	53	62	70	73	72	70	64	53	57	67
LWA to outlet [dBA]	81	57	65	73	77	74	71	64	54	60	70
LWA to environment [dBA]	71	47	50	63	66	66	62	55	44	50	60

PRIMO EC 315 MAX

Sound power level, A-weighted	Total	Octave frequency bands [Hz]								LpA 3 m	LpA 1 m
		63	125	250	500	1000	2000	4000	8000		
LWA to inlet [dBA]	83	73	76	75	75	78	74	69	61	63	73
LWA to outlet [dBA]	85	70	79	75	77	81	76	71	64	65	75
LWA to environment [dBA]	76	56	64	67	70	71	68	63	53	55	65

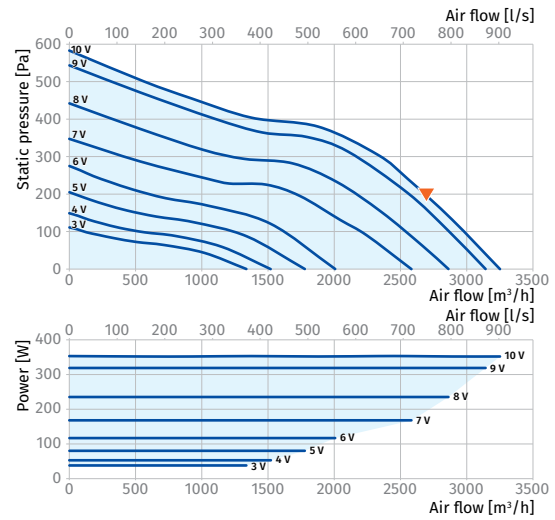
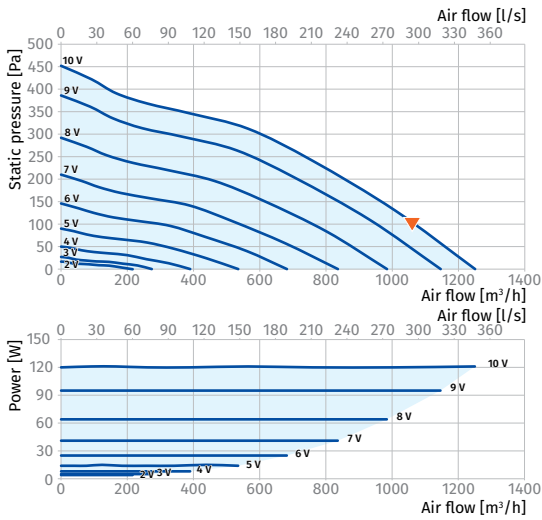

INLINE FANS

Parameters	Primo EC 355	Primo EC 355 max
Voltage [V]	1~ 230	1~ 230
Frequency [Hz]	50	50
Power [W]	353	701
Current [A]	1.56	3.10
Maximum air flow [m³/h (l/s)]	3685 (1024)	4630 (1286)
RPM [min ⁻¹]	2470	3175
Sound pressure at 3 m [dBA]	55	60
Transported air temperature [°C]	-25...+55	-25...+55
Protection rating	IPX4	IPX4
Motor protection rating	IP44	IP44
Erp compliance	2018	2018

PRIMO EC 355

Sound power level, A-weighted	Total	Octave frequency bands [Hz]								LpA 3 m	LpA 1 m
		63	125	250	500	1000	2000	4000	8000		
LWA to inlet [dBA]	83	73	76	75	75	78	74	69	61	63	73
LWA to outlet [dBA]	85	70	79	75	77	81	76	71	64	65	75
LWA to environment [dBA]	76	56	64	67	70	71	68	63	53	55	65

PRIMO EC 355 MAX

Sound power level, A-weighted	Total	Octave frequency bands [Hz]								LpA 3 m	LpA 1 m
		63	125	250	500	1000	2000	4000	8000		
LWA to inlet [dBA]	88	74	82	79	79	83	80	75	66	68	78
LWA to outlet [dBA]	90	72	83	79	81	86	82	77	70	70	80
LWA to environment [dBA]	80	45	63	66	73	77	74	68	57	60	70

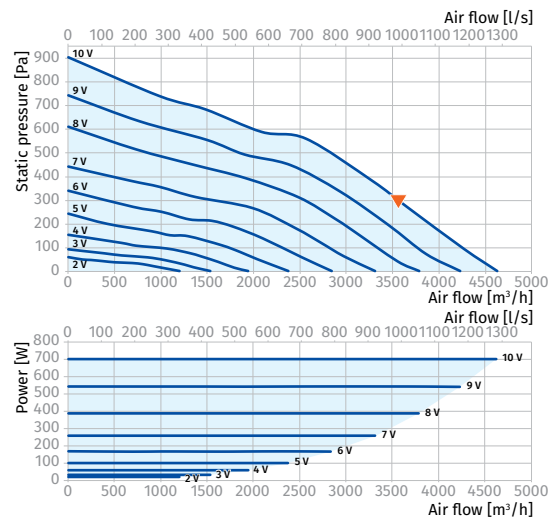
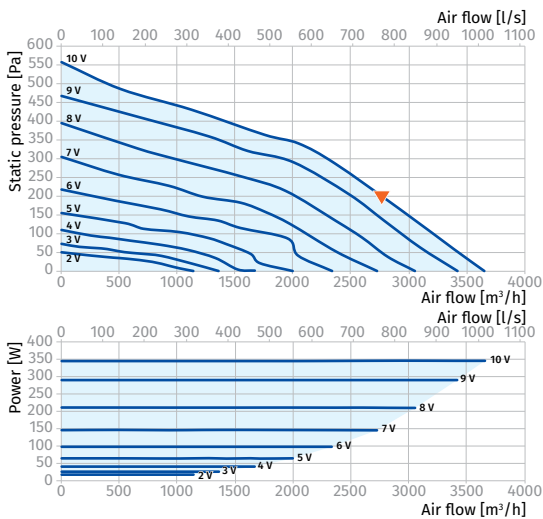

Parameters	Primo EC 400
Voltage [V]	1~ 230
Frequency [Hz]	50
Power [W]	726
Current [A]	3.23
Maximum air flow [m³/h (l/s)]	5700 (1583)
RPM [min⁻¹]	2580
Sound pressure at 3 m [dBA]	60
Transported air temperature [°C]	-25...+55
Protection rating	IPX4
Motor protection rating	IP44
Erp compliance	2018

PRIMO EC 400

Sound power level, A-weighted	Total	Octave frequency bands [Hz]								LpA 3 m	LpA 1 m
		63	125	250	500	1000	2000	4000	8000		
L _{WA} to inlet [dBA]	87	70	77	78	81	81	79	74	67	66	76
L _{WA} to outlet [dBA]	88	62	76	78	83	84	80	75	66	68	78
L _{WA} to environment [dBA]	80	59	66	69	74	77	72	67	58	60	70

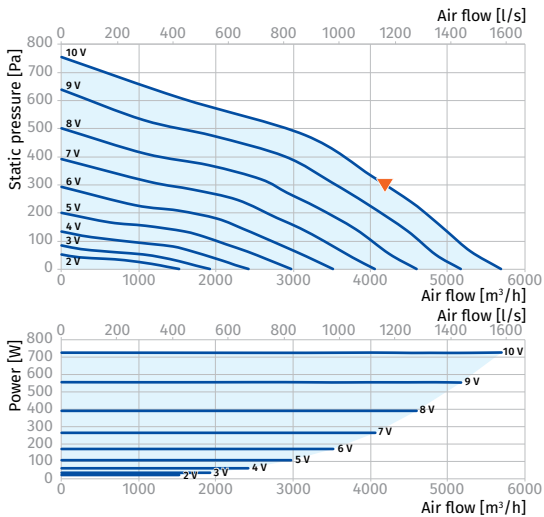

INLINE FANS