

# Box-I

## Centrifugal fans in sound-insulated casing for rectangular ducts

### Use

- Supply and exhaust ventilation systems installed in various premises.
- Compatible with 400x200 up to 600x350 mm rectangular air ducts.



**Air flow:**  
up to 3515 m<sup>3</sup>/h  
976 l/s



**Power:**  
from 136 W



**Noise level:**  
from 45 dBA



### Design

- Atmospheric resistant galvanized steel casing and impeller.
- The casing is heat- and sound-insulated with 50 mm mineral wool.
- The fan is rated for continuous operation.
- Fitted with standard 20 mm connecting flanges for connection to rectangular air ducts.
- Access cover on the casing for inspection and maintenance operations.
- The fan is equipped with a built-in terminal box with a leaded outside sealed electrical lead-in for connection to power mains.

### Motor

- Two- or four-pole asynchronous motor with external rotor and centrifugal impeller with backward curved blades.
- Single-phase (**E**) or three-phase (**D**) motor modifications.
- Equipped with ball bearings for longer service life.
- Dynamically balanced impeller.
- Overheating protection by built-in thermal switches with automatic restart or with leaded outside terminals for connection to external protecting controls.
- The thermal switch terminal leads are designed for connection to respective circuit of the contactor, overload relay or respective terminals of the autotransformer or thyristor speed controller.

### Speed control

- Smooth speed control with an external thyristor controller or step speed control with an external auto transformer (both available upon separate order).

### Mounting

- The fan is designed for mounting inside rectangular air ducts and can be installed in any position.
- The fan flanges are connected to the air ducts through the bolts inserted into the flange holes.
- The fan is suitable for mounting into round duct at intake flange with a round reducer (available upon separate order).
- If vibration-absorbing flexible connectors are used to connect the fan to the air ducts provide their fixation to mounting structures with supports or brackets.
- While mounting provide enough space for accessing the cover for service operations.

INLINE FANS FOR RECTANGULAR DUCTS

### Designation key

Series	Flange size (width x height) [cm]	Motor Number of poles	Phase
Box-I	40x20; 50x25; 50x30; 60x30; 60x35	2; 4	E: single-phase D: three-phase

### Accessories

Silencers	Filter boxes	Electric heaters	Water heaters	Air dampers	Gravity dampers	Flexible antivibration connectors	Speed controllers
 SD	 KFBK / KFBT	 EKH	 WKH	 SL	 VG	 EVA	 CDTE 1.8

### Overall dimensions [mm]

Type	B	B1	B2	B3	H	H1	H2	H3	L	Weight [kg]
Box-I 40x20 2E	400	420	440	500	200	220	240	360	500	24.5
Box-I 50x25 2E	500	520	540	600	250	270	290	410	640	27.6
Box-I 50x30 4E	500	520	540	600	300	320	340	460	680	37.2
Box-I 50x30 4D	500	520	540	600	300	320	340	460	680	37.2
Box-I 60x30 4E	600	620	640	700	300	320	340	460	680	43.5
Box-I 60x30 4D	600	620	640	700	300	320	340	460	680	43.5
Box-I 60x35 4E	600	620	640	700	350	370	390	530	735	56.2
Box-I 60x35 4D	600	620	640	700	350	370	390	530	735	56.2

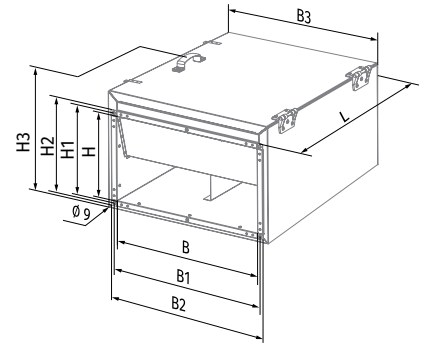

### Technical data

Parameters	Box-I 40x20 2E	Box-I 50x25 2E
Voltage [V]	1 ~ 230	1 ~ 230
Frequency [Hz]	50	60
Power [W]	138	305
Current [A]	0.6	1.32
Maximum air flow [m³/h (l/s)]	930 (258)	1720 (478)
RPM [min⁻¹]	2600	2550
Sound pressure at 3 m [dBA]	45	51
Transported air temperature [°C]	-25...+45	-25...+45
IP rating	IPX4	IPX4
Motor IP rating	IP44	IP44
ErP	2018	2018

#### BOX-I 40x20 2E

Sound power level, A-weighted	Total	Octave frequency bands [Hz]								LpA 3 m	LpA 1 m
		63	125	250	500	1000	2000	4000	8000		
LWA to inlet [dBA]	75	64	70	70	66	61	61	58	51	54	64
LWA to outlet [dBA]	79	66	70	73	72	69	69	68	61	58	68
LWA to environment [dBA]	66	42	54	61	60	61	51	47	37	45	55

#### BOX-I 50x25 2E

Sound power level, A-weighted	Total	Octave frequency bands [Hz]								LpA 3 m	LpA 1 m
		63	125	250	500	1000	2000	4000	8000		
LWA to inlet [dBA]	75	62	69	71	60	63	67	64	59	55	65
LWA to outlet [dBA]	79	63	68	71	70	74	71	71	65	59	69
LWA to environment [dBA]	72	40	55	67	67	64	59	53	44	51	61

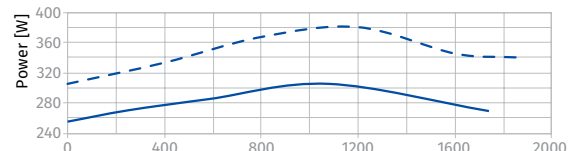
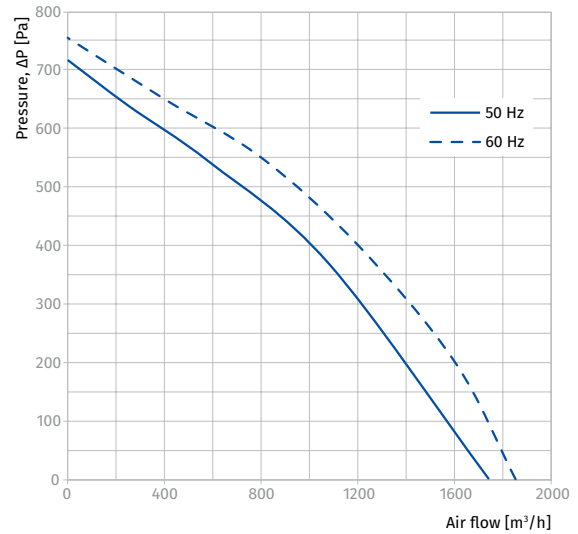
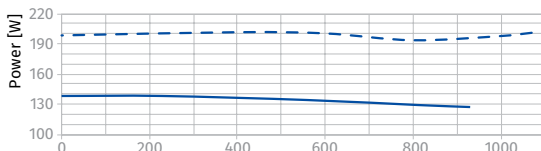
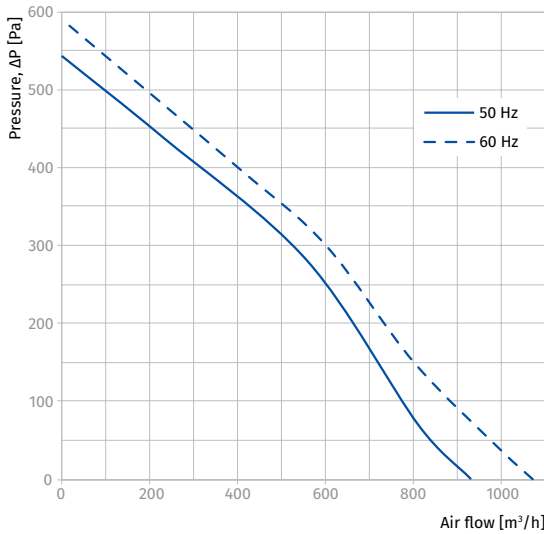

Parameters	Box-I 50x30 4E		Box-I 50x30 4D	
Voltage [V]	1 ~ 230		3 ~ 400	
Frequency [Hz]	50	60	50	60
Power [W]	140	175	136	165
Current [A]	0.57	0.73	0.34	0.53
Maximum air flow [m <sup>3</sup> /h (l/s)]	1700 (472)	1855 (515)	1380 (383)	1620 (450)
RPM [min <sup>-1</sup> ]	1390	1530	1360	1600
Sound pressure at 3 m [dBA]	48	50	47	50
Transported air temperature [°C]	-25...+45	-25...+50	-25...+65	-25...+55
IP rating	IPX4		IPX4	
Motor IP rating	IP44		IP44	
ErP	2018		2018	

**BOX-I 50x30 4E**

Sound power level, A-weighted	Total	Octave frequency bands [Hz]								LpA 3 m	LpA 1 m
		63	125	250	500	1000	2000	4000	8000		
L <sub>WA</sub> to inlet [dBA]	78	60	68	70	62	74	72	68	62	58	68
L <sub>WA</sub> to outlet [dBA]	83	57	68	72	72	77	77	75	70	62	72
L <sub>WA</sub> to environment [dBA]	69	46	58	64	61	61	60	56	51	48	58

**BOX-I 50x30 4D**

Sound power level, A-weighted	Total	Octave frequency bands [Hz]								LpA 3 m	LpA 1 m
		63	125	250	500	1000	2000	4000	8000		
L <sub>WA</sub> to inlet [dBA]	77	59	67	69	61	73	71	67	61	56	66
L <sub>WA</sub> to outlet [dBA]	81	56	67	71	71	75	75	74	69	61	71
L <sub>WA</sub> to environment [dBA]	68	46	57	63	60	60	59	55	50	47	57

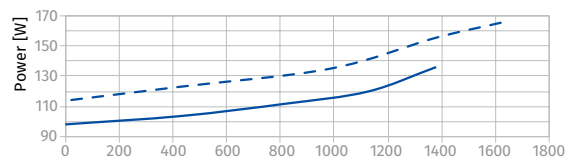
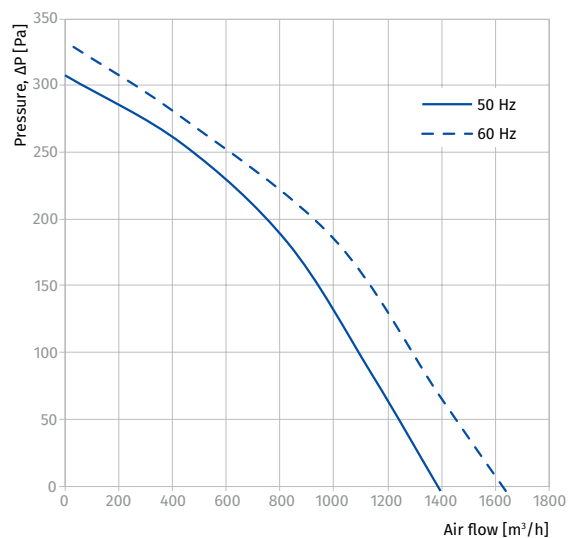
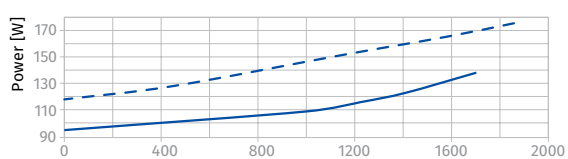
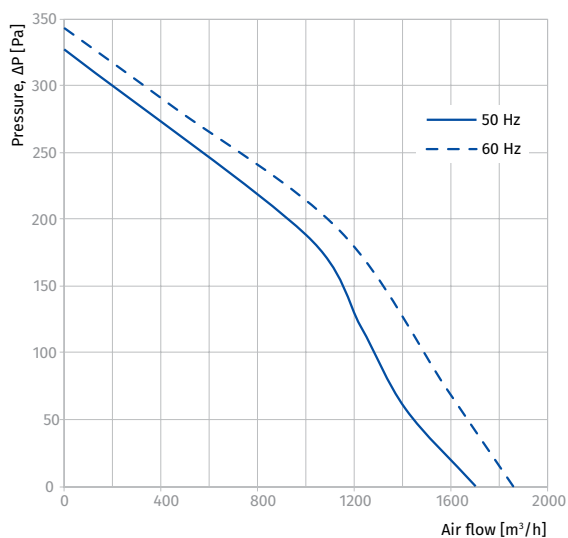

Parameters	Box-I 60x30 4E		Box-I 60x30 4D	
Voltage [V]	1 ~ 230		3 ~ 400	
Frequency [Hz]	50	60	50	60
Power [W]	220	310	230	235
Current [A]	0.9	1.38	0.52	0.53
Maximum air flow [m³/h (l/s)]	2470 (686)	2510 (697)	2530 (703)	2630 (731)
RPM [min⁻¹]	1400	1450	1360	1600
Sound pressure at 3 m [dBA]	46	46	45	47
Transported air temperature [°C]	-25...+45	-25...+40	-25...+70	-25...+65
IP rating	IPX4		IPX4	
Motor IP rating	IP44		IP44	
ErP	2018		2018	

**BOX-I 60x30 4E**

Sound power level, A-weighted	Total	Octave frequency bands [Hz]								LpA 3 m	LpA 1 m
		63	125	250	500	1000	2000	4000	8000		
L <sub>WA</sub> to inlet [dBA]	81	70	77	77	72	66	66	64	55	61	71
L <sub>WA</sub> to outlet [dBA]	85	72	77	80	79	75	75	74	66	65	75
L <sub>WA</sub> to environment [dBA]	67	43	55	62	61	62	53	48	38	46	56

**BOX-I 60x30 4D**

Sound power level, A-weighted	Total	Octave frequency bands [Hz]								LpA 3 m	LpA 1 m
		63	125	250	500	1000	2000	4000	8000		
L <sub>WA</sub> to inlet [dBA]	80	69	75	75	71	65	65	63	54	59	69
L <sub>WA</sub> to outlet [dBA]	84	71	75	78	77	74	74	73	65	63	73
L <sub>WA</sub> to environment [dBA]	66	43	54	61	60	61	52	48	38	45	55

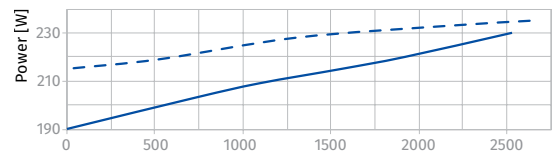
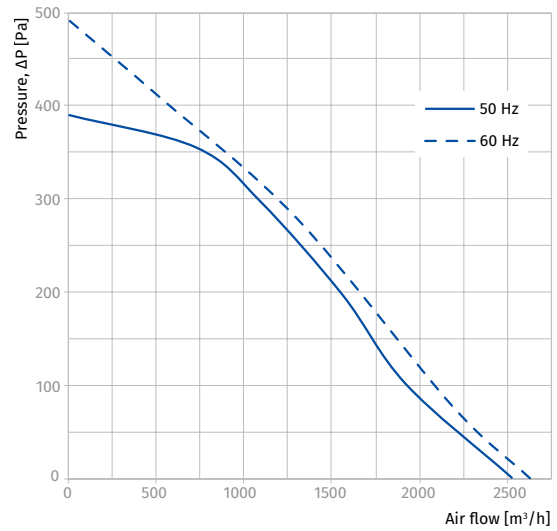
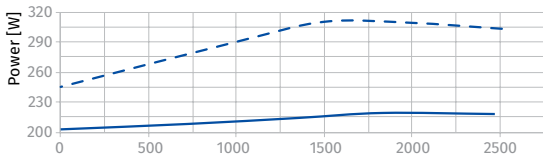
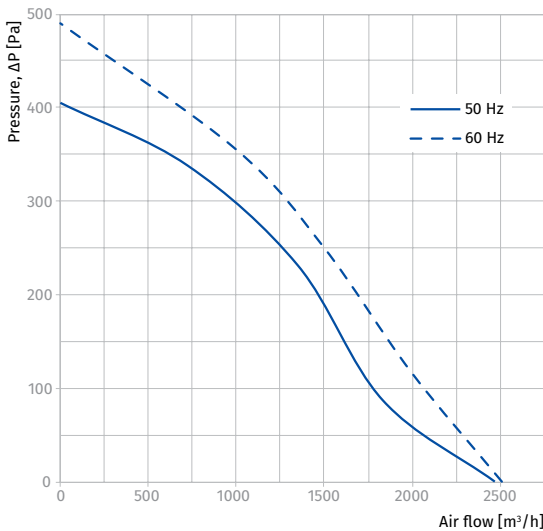

INLINE FANS FOR RECTANGULAR DUCTS

Parameters	Box-I 60x35 4E		Box-I 60x35 4D			
Voltage [V]	1 ~ 230		3 ~ 400 Δ		3 ~ 400 Y	
Frequency [Hz]	50	60	50	60	50	60
Power [W]	470	700	510	750	380	515
Current [A]	2.37	3.15	1.41	1.44	0.7	0.93
Maximum air flow [m³/h (l/s)]	2950 (820)	3515 (976)	2970 (825)	3410 (947)	2660 (739)	2730 (758)
RPM [min <sup>-1</sup> ]	1370	1460	1415	1610	1235	1220
Sound pressure at 3 m [dBA]	47	47	46	46	46	46
Transported air temperature [°C]	-40...+80	-40...+55	-40...+60	-40...+60	-40...+80	-40...+40
IP rating	IPX4		IPX4		IPX4	
Motor IP rating	IP44		IP44		IP44	
ErP	2018		2018		2018	

**BOX-I 60x35 4E**

Sound power level, A-weighted	Total	Octave frequency bands [Hz]								LpA 3 m	LpA 1 m
		63	125	250	500	1000	2000	4000	8000		
L <sub>WA</sub> to inlet [dBA]	81	73	77	73	70	71	70	68	58	61	71
L <sub>WA</sub> to outlet [dBA]	83	72	72	73	74	78	77	74	62	63	73
L <sub>WA</sub> to environment [dBA]	68	40	55	61	63	62	57	54	46	47	57

**BOX-I 60x35 4D**

Sound power level, A-weighted	Total	Octave frequency bands [Hz]								LpA 3 m	LpA 1 m
		63	125	250	500	1000	2000	4000	8000		
L <sub>WA</sub> to inlet [dBA]	80	73	76	73	69	70	69	68	57	60	70
L <sub>WA</sub> to outlet [dBA]	83	71	71	73	74	77	76	74	62	62	72
L <sub>WA</sub> to environment [dBA]	67	40	54	60	62	61	56	53	46	46	56

INLINE FANS FOR RECTANGULAR DUCTS

