

Centro-M

Inline centrifugal fans

Use

- Supply and extract ventilation systems installed in various premises.
- Direct mounting inside air ductworks.
- Compatible with Ø 100 to 450 mm round air ducts.



Air flow:
up to 6280 m³/h
1745 l/s



Power:
from 45 W



Noise level:
from 38 dBA



Design

- The casing is made of steel with a special polymer coating.
- Aerodynamically shaped casing.
- External terminal box for connection to power mains.

Motor

- Single-phase external rotor motor with a centrifugal impeller with backward curved blades.
- Equipped with ball bearings for longer service life.
- Overheat protection with built-in thermal switches with automatic restart.
- Dynamically balanced impeller.
- Some standard sizes have high-powered motors (**Centro-M max**).
- For ventilation of premises with high requirements to noise level low-noise modifications are available (**Centro-M L**).

Speed control

- Smooth speed control with an external thyristor controller or step speed control with an external auto transformer (both available upon separate order).

Mounting

- Any mounting position.
- The fans with the connecting diameter from 100 up to 315 mm are fixed to wall or ceiling with mounting brackets supplied as a standard.
- The fans with the connecting diameter from 355 up to 450 mm are fixed with mounting brackets fixed on the casing.
- Flexible air ducts are fixed on the fan spigots with clamps.

Modifications and options

- max:** high-powered motor.
- L:** low-powered and low-noise motor.
- E:** energy-efficient motor with low power consumption.
- FR1 (for standard sizes 100–315):** smooth speed controller adjustable from 0 to 100 % and power cable with mains plug.



- G1:** speed controller, temperature controller with external temperature sensor (cable length 4 m), power cable with mains plug.
- W1:** power cable with mains plug.









Centro-M 100 – Centro-M 315



Centro-M 355 – Centro-M 450

Accessories

Silencers	Filter boxes	Electric heaters	Water heaters	Backdraft air dampers	Air dampers	Speed controllers
						
SD	KFBK / KFBT	EKH	WKH	VRV	VK / VKA	CDT E1.8

Designation key			
Series	Duct diameter [mm]	Motor modifications	Options
Centro-M	100; 125; 150; 160; 200; 250; 315; 355; 400; 450	max: high-powered motor L: low-powered motor E: motor with low power consumption	FR1 (for standard sizes 100-315): smooth speed controller adjustable from 0 to 100 % and power cable with mains plug G1: speed controller, temperature controller with external temperature sensor, power cable with mains plug W1: power cable with mains plug

Overall dimensions [mm]

Type	∅ D	∅ D1	B	B1	L	L1	L2	L3	Weight [kg]
Centro-M 100 L	98	255	310	270	205	20	25	30	2.1
Centro-M 100	98	255	310	270	205	20	25	30	2.4
Centro-M 125 L	123	255	310	270	205	20	25	30	2.9
Centro-M 125	123	255	310	270	205	20	25	30	3.2
Centro-M 150	149	345	395	355	200	20	20	40	4.7
Centro-M 150 max	149	345	395	355	230	20	20	40	5.4
Centro-M 160	159	305	360	320	220	25	25	30	5.0
Centro-M 160 max	158	340	390	350	245	25	20	40	6.4
Centro-M 200	198	345	395	355	255	25	30	40	6.6
Centro-M 200 max	198	345	395	355	255	25	30	40	8.3
Centro-M 250 E	248	345	395	355	250	25	30	40	6.2
Centro-M 250	248	345	395	355	250	25	30	40	8.4
Centro-M 315	314	405	455	415	260	30	30	40	8.0
Centro-M 315 max	314	405	455	415	290	30	30	40	8.8
Centro-M 355 L	353	460	522	522	506	60	60	70	18.8
Centro-M 400	398	570	663	634	570	60	60	70	25.1
Centro-M 450	448	608	700	670	644	60	60	80	27.26

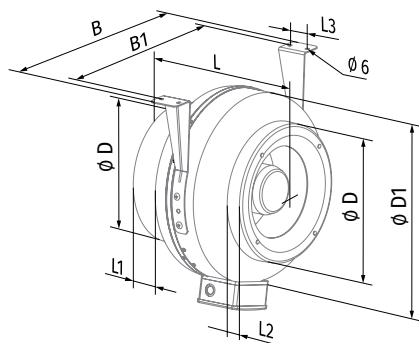

Centro-M 100 – Centro-M 315

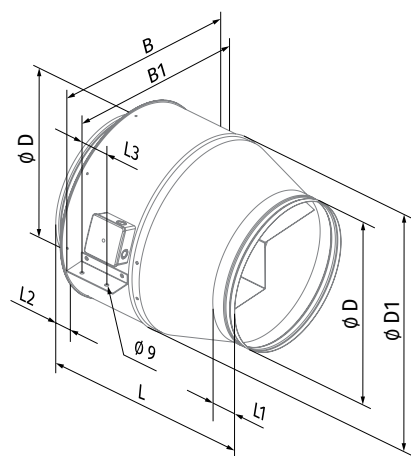

Centro-M 355 – Centro-M 450

Technical data

Parameters	Centro-M 100 L		Centro-M 100		Centro-M 125 L		Centro-M 125	
Voltage [V]	1 ~ 220-240		1 ~ 220-240		1 ~ 220-240		1 ~ 220-240	
Frequency [Hz]	50	60	50	60	50	60	50	60
Power [W]	45	50	60	82	47	54	64	85
Current [A]	0.24	0.23	0.28	0.36	0.25	0.24	0.29	0.37
Air flow [m³/h (l/s)]	233 (65)	267 (74)	279 (78)	278 (77)	326 (91)	370 (103)	360 (100)	357 (99)
RPM [min⁻¹]	2780	3300	2840	3320	2760	3240	2840	3300
Sound pressure level at 3 m [dBA]	38	39	40	41	37	38	40	42
Transported air temperature [°C]	-25...+45		-25...+45		-25...+45		-25...+45	
SEC class	C	-	C	-	C	-	C	-
IP rating	IPX4		IPX4		IPX4		IPX4	
Motor IP rating	IP44		IP44		IP44		IP44	
ErP	2018	-	2018	-	2018	-	2018	-

To comply with ErP 2018 it is necessary to use a speed controller and local demand control typology (connect the sensor).

CENTRO-M 100 L, CENTRO-M 100

Sound power level, A-weighted	Total	Octave frequency bands [Hz]								LpA 3 m	LpA 1 m
		63	125	250	500	1000	2000	4000	8000		
Centro-M 100 L											
LWA to inlet [dBA]	78	56	70	77	68	63	59	53	43	58	68
LWA to outlet [dBA]	77	63	70	75	67	60	56	52	41	57	67
LWA to environment [dBA]	59	27	47	49	53	54	51	42	32	38	48
Centro-M 100											
LWA to inlet [dBA]	84	56	76	82	72	68	65	59	50	63	73
LWA to outlet [dBA]	83	63	76	81	71	65	62	57	49	62	72
LWA to environment [dBA]	60	29	44	52	55	54	54	44	31	40	50

CENTRO-M 125 L, CENTRO-M 125

Sound power level, A-weighted	Total	Octave frequency bands [Hz]								LpA 3 m	LpA 1 m
		63	125	250	500	1000	2000	4000	8000		
Centro-M 125 L											
LWA to inlet [dBA]	79	57	71	77	69	64	60	54	43	58	68
LWA to outlet [dBA]	78	64	71	76	68	61	57	53	41	58	68
LWA to environment [dBA]	58	27	46	48	52	53	50	41	32	37	47
Centro-M 125											
LWA to inlet [dBA]	83	60	75	81	73	67	63	57	46	62	72
LWA to outlet [dBA]	82	67	75	80	72	64	60	55	44	61	71
LWA to environment [dBA]	61	28	49	51	55	57	53	44	34	40	50

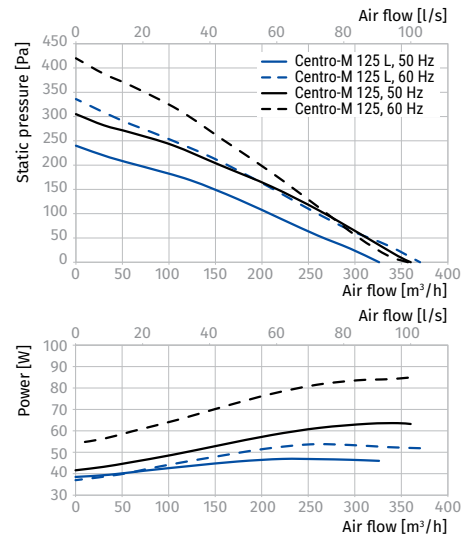
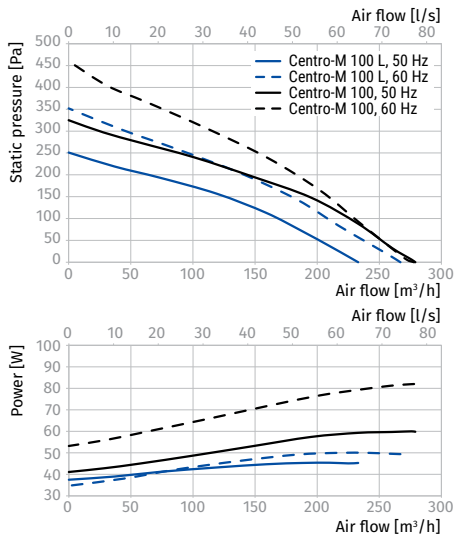

INLINE FANS

Parameters	Centro-M 150		Centro-M 150 max		Centro-M 160		Centro-M 160 max	
Voltage [V]	1 ~ 220-240		1 ~ 220-240		1 ~ 220-240		1 ~ 220-240	
Frequency [Hz]	50	60	50	60	50	60	50	60
Power [W]	100	125	127	174	99	137	121	170
Current [A]	0.45	0.55	0.55	0.76	0.44	0.61	0.53	0.75
Air flow [m³/h (l/s)]	580 (161)	610 (169)	710 (197)	750 (208)	567 (158)	575 (160)	690 (192)	730 (203)
RPM [min⁻¹]	2700	3100	2760	3150	2770	3160	2800	3210
Sound pressure level at 3 m [dBA]	45	46	48	49	45	47	48	49
Transported air temperature [°C]	-25...+45		-25...+45		-25...+45		-25...+45	
SEC class	C	-	C	-	C	-	C	-
IP rating	IPX4		IPX4		IPX4		IPX4	
Motor IP rating	IP44		IP44		IP44		IP44	
ErP	2018	-	2018	-	2018	-	2018	-

To comply with ErP 2018 it is necessary to use a speed controller and local demand control typology (connect the sensor).

CENTRO-M 150, CENTRO-M 150 MAX

Sound power level, A-weighted	Total	Octave frequency bands [Hz]								LpA 3 m	LpA 1 m
		63	125	250	500	1000	2000	4000	8000		
Centro-M 150											
LWA to inlet [dBA]	90	53	87	86	75	74	71	68	54	69	79
LWA to outlet [dBA]	90	53	88	85	72	71	66	65	52	69	79
LWA to environment [dBA]	66	28	49	58	60	60	60	50	37	45	55
Centro-M 150 max											
LWA to inlet [dBA]	94	56	91	90	79	78	75	71	57	74	84
LWA to outlet [dBA]	94	56	92	89	76	75	69	68	55	74	84
LWA to environment [dBA]	68	29	51	61	63	63	63	52	39	48	58

CENTRO-M 160, CENTRO-M 160 MAX

Sound power level, A-weighted	Total	Octave frequency bands [Hz]								LpA 3 m	LpA 1 m
		63	125	250	500	1000	2000	4000	8000		
Centro-M 160											
LWA to inlet [dBA]	88	52	85	84	74	73	70	67	53	68	78
LWA to outlet [dBA]	87	51	85	82	70	69	64	63	50	67	77
LWA to environment [dBA]	65	28	48	58	58	60	59	51	38	45	55
Centro-M 160 max											
LWA to inlet [dBA]	93	55	90	89	78	77	74	71	56	73	83
LWA to outlet [dBA]	93	55	92	88	75	74	69	68	54	73	83
LWA to environment [dBA]	68	29	51	60	63	63	63	52	38	48	58

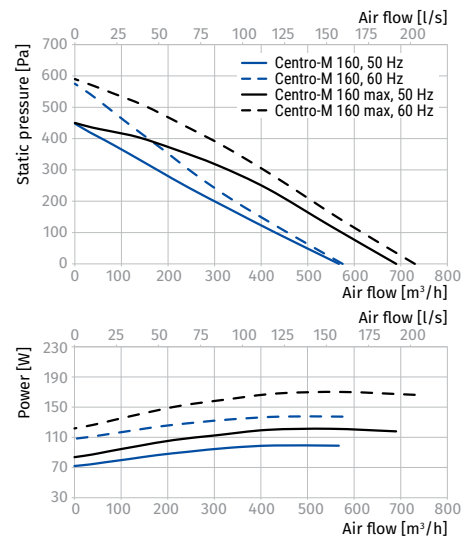
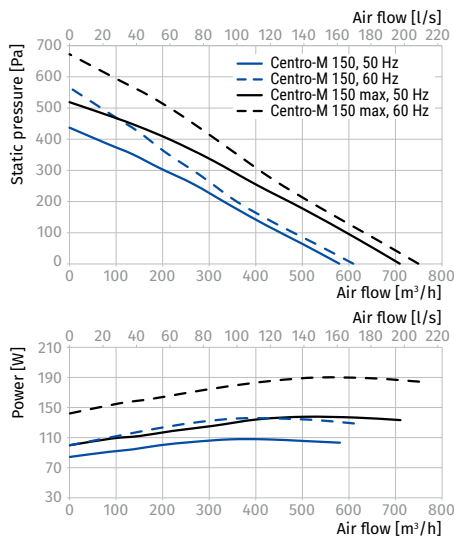

INLINE FANS

Parameters	Centro-M 200		Centro-M 200 max		Centro-M 250 E		Centro-M 250	
Voltage [V]	1 ~ 220-240		1 ~ 220-240		1 ~ 220-240		1 ~ 220-240	
Frequency [Hz]	50	60	50	60	50	50	60	60
Power [W]	135	182	193	240	95	194	240	
Current [A]	0.59	0.79	0.84	1.05	0.47	0.85	1.05	
Air flow [m³/h (l/s)]	1070 (294)	1220 (339)	1150 (319)	1200 (333)	900 (250)	1420 (394)	1520 (422)	
RPM [min⁻¹]	2710	3120	2780	2850	2050	2790	2860	
Sound pressure level at 3 m [dBA]	48	50	49	49	47	50	51	
Transported air temperature [°C]	-25...+45		-25...+45		-25...+45		-25...+45	
SEC class	C	-	-	-	C	-	-	
IP rating	IPX4		IPX4		IPX4		IPX4	
Motor IP rating	IP44		IP44		IP44		IP44	
ErP	2018	-	2018	-	2018	2018	-	

To comply with ErP 2018 it is necessary to use a speed controller and local demand control typology (connect the sensor).

CENTRO-M 200, CENTRO-M 200 MAX

Sound power level, A-weighted	Total	Octave frequency bands [Hz]								LpA 3 m	LpA 1 m
		63	125	250	500	1000	2000	4000	8000		
Centro-M 200											
LWA to inlet [dBA]	90	49	78	87	81	81	82	74	63	69	79
LWA to outlet [dBA]	87	46	77	81	79	79	82	74	64	67	77
LWA to environment [dBA]	68	29	52	60	63	63	62	53	39	48	58
Centro-M 200 max											
LWA to inlet [dBA]	95	56	92	91	79	78	75	72	57	74	84
LWA to outlet [dBA]	94	56	92	89	75	74	69	68	54	74	84
LWA to environment [dBA]	70	29	52	62	64	64	64	53	39	49	59

CENTRO-M 250 E, CENTRO-M 250

Sound power level, A-weighted	Total	Octave frequency bands [Hz]								LpA 3 m	LpA 1 m
		63	125	250	500	1000	2000	4000	8000		
Centro-M 250 E											
LWA to inlet [dBA]	89	60	76	83	81	83	79	75	64	68	78
LWA to outlet [dBA]	87	63	75	72	80	82	80	75	62	66	76
LWA to environment [dBA]	67	34	48	59	62	62	60	49	38	47	57
Centro-M 250											
LWA to inlet [dBA]	90	61	78	85	83	85	81	77	65	70	80
LWA to outlet [dBA]	88	64	77	73	82	84	82	77	63	68	78
LWA to environment [dBA]	71	38	52	62	66	65	64	58	44	50	60

INLINE FANS

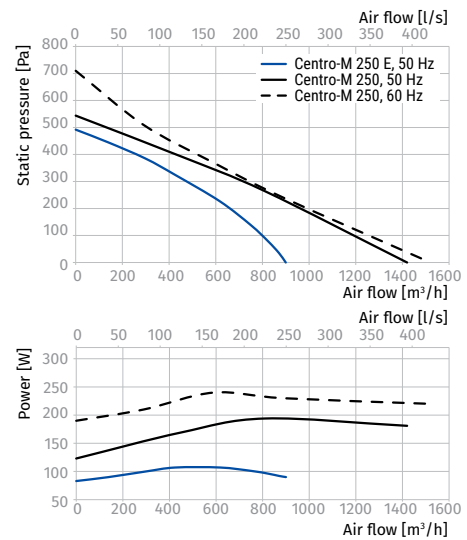
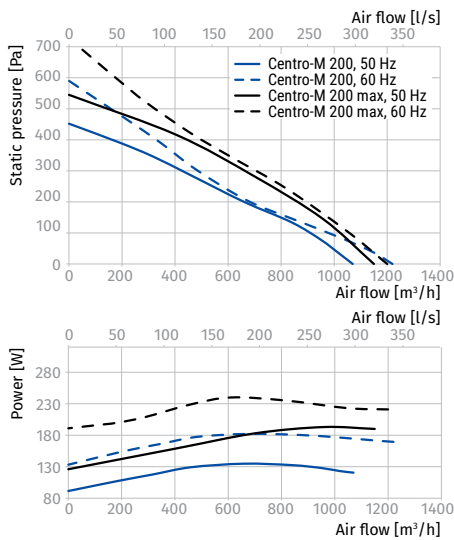

Parameters	Centro-M 315		Centro-M 315 max		Centro-M 355 L	
Voltage [V]	1 ~ 220-240		1 ~ 220-240		1 ~ 220-240	
Frequency [Hz]	50	60	50	60	50	60
Power [W]	171	241	295	413	233	297
Current [A]	0.77	1.05	1.34	1.8	1.06	1.30
Air flow [m³/h (l/s)]	1440 (400)	1550 (431)	1920 (533)	1980 (550)	2250 (625)	2350 (653)
RPM [min⁻¹]	2600	2850	2720	2780	1375	1620
Sound pressure level at 3 m [dBA]	52	53	54	55	58	59
Transported air temperature [°C]	-25...+45		-25...+45		-25...+45	
SEC class	-	-	-	-	-	-
IP rating	IPX4		IPX4		IPX4	
Motor IP rating	IP44		IP44		IP44	
ErP	2018	-	2018	-	2018	-

To comply with ErP 2018 it is necessary to use a speed controller and local demand control typology (connect the sensor).

CENTRO-M 315, CENTRO-M 315 MAX

Sound power level, A-weighted	Total	Octave frequency bands [Hz]								LpA 3 m	LpA 1 m
		63	125	250	500	1000	2000	4000	8000		
Centro-M 315											
LWA to inlet [dBA]	92	62	80	87	85	87	83	79	66	71	81
LWA to outlet [dBA]	91	66	79	75	84	87	84	79	65	70	80
LWA to environment [dBA]	72	37	51	64	67	67	65	53	41	52	62
Centro-M 315 max											
LWA to inlet [dBA]	94	63	81	88	86	88	84	80	68	73	83
LWA to outlet [dBA]	92	67	81	77	86	88	86	81	66	72	82
LWA to environment [dBA]	74	38	53	66	69	69	67	54	42	54	64

CENTRO-M 355 L

Sound power level, A-weighted	Total	Octave frequency bands [Hz]								LpA 3 m	LpA 1 m
		63	125	250	500	1000	2000	4000	8000		
LWA to inlet [dBA]	95	57	82	80	84	90	91	86	75	74	84
LWA to outlet [dBA]	96	61	74	84	81	90	93	85	77	75	85
LWA to environment [dBA]	78	33	55	64	72	74	74	64	56	58	68

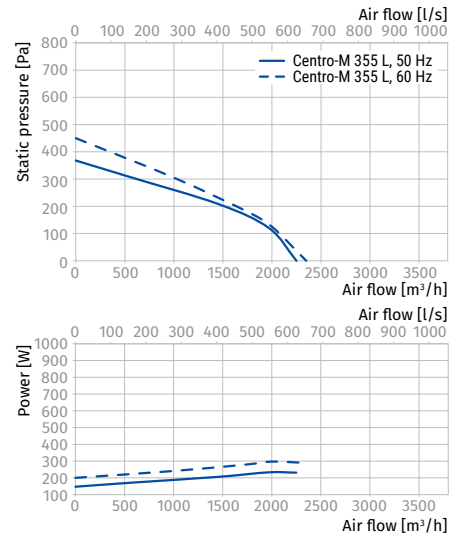
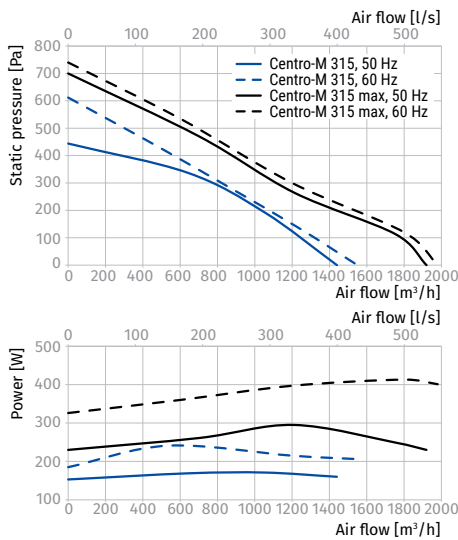

Parameters	Centro-M 400		Centro-M 450	
Voltage [V]	1 ~ 220-240		1 ~ 220-240	
Frequency [Hz]	50	60	50	60
Power [W]	460	673	665	1250
Current [A]	2.23	3.05	2.89	5.40
Air flow [m³/h (l/s)]	3090 (858)	3500 (972)	5300 (1472)	6280 (1745)
RPM [min⁻¹]	1370	1585	1265	1560
Sound pressure level at 3 m [dBA]	61	64	65	73
Transported air temperature [°C]	-40...+80	-40...+55	-40...+70	-25...+60
SEC class	-	-	-	-
IP rating	IPX4		IPX4	
Motor IP rating	IP44		IP44	
ErP	-		2018	-

To comply with ErP 2018 it is necessary to use a speed controller and local demand control typology (connect the sensor).

CENTRO-M 400

Sound power level, A-weighted	Total	Octave frequency bands [Hz]								LpA 3 m	LpA 1 m
		63	125	250	500	1000	2000	4000	8000		
LWA to inlet [dBA]	97	59	84	82	86	92	93	88	78	77	87
LWA to outlet [dBA]	96	61	75	85	82	90	94	86	78	76	86
LWA to environment [dBA]	81	35	57	66	75	77	77	66	58	61	71

CENTRO-M 450

Sound power level, A-weighted	Total	Octave frequency bands [Hz]								LpA 3 m	LpA 1 m
		63	125	250	500	1000	2000	4000	8000		
LWA to inlet [dBA]	98	59	85	83	87	93	94	89	78	78	88
LWA to outlet [dBA]	98	63	76	87	84	92	95	88	80	78	88
LWA to environment [dBA]	86	37	60	70	79	81	81	70	61	65	75

