

Centro-M EC

Inline centrifugal fans with EC motor

Use

- Supply and extract ventilation systems installed in various premises.
- Direct mounting inside air ductworks.
- For arranging energy-saving and controllable ventilation systems.
- Compatible with Ø 100 to 315 mm round air ducts.



Air flow:
up to 1370 m³/h
381 l/s



Power:
from 83 W



Noise level:
from 44 dBA



Design

- The casing is made of steel with a special polymer coating.
- Aerodynamically shaped casing.
- External terminal box for connection to power mains.

Motor

- High-efficient direct current EC motor with external rotor and backward curved blades.
- EC technology meets the up-to-date requirements to energy-saving and controllable ventilation and provides up to 35 % energy saving as compared to asynchronous motors.
- EC motor ensures totally controllable speed range for the fan and has integrated overheating protection with automatic restart.
- EC motor has no friction and wearing parts as capacitor and brushes. Instead a maintenance-free EC controller electronic circuit board is used.
- The impeller is dynamically balanced.
- The fan is compatible with 50 Hz and 60 Hz power mains and the maximum speed does not depend on power mains frequency.

Operation and speed control

- The fan speed is controlled with a 0–10 V control signal from the following sources:
 - integrated or external speed controller
 - controller with sensors
 - central BMS system.
- The control signal value changes depending on air temperature, pressure, smoke concentration and other parameters.
- During signal value change the fan with EC motor correspondingly changes the rotations speed and delivers required air volume to the ventilation system.
- The computer central building management systems (BMS) enable integration of several EC motors in network and precise individual operation control for each fan.

Mounting

- Any mounting position.
- Fans are fixed to wall or ceiling with mounting brackets supplied as a standard.
- Flexible air ducts are fixed on the fan spigots with clamps.

Designation key

Series	Motor type	Duct diameter [mm]	Options
Centro-M	EC: electronically commutated motor	100; 125; 150; 160; 200; 250; 315	max: high-powered motor FR1: smooth speed controller adjustable from 0 to 100 % and power cable with mains plug G1: speed controller, temperature controller with external temperature sensor, power cable with mains plug W1: power cable with mains plug

Accessories

Silencers	Filter boxes	Electric heaters	Water heaters	Backdraft air dampers	Air dampers	Clamps	Speed controllers
 SD	 KFBK / KFBT	 EKH	 WKH	 VRV	 VK / VKA	 KZ	 CDT E1.8

Overall dimensions [mm]

Type	Ø D	Ø D1	B	B1	L	L1	L2	L3	Weight [kg]
Centro-M EC 100	98	255	310	270	203	20	25	30	3.45
Centro-M EC 125	123	255	310	270	203	20	25	30	3.58
Centro-M EC 150	149	305	360	320	240	25	25	30	4.70
Centro-M EC 160	159	305	360	320	240	25	25	30	4.90
Centro-M EC 200	198	345	395	355	245	25	30	40	5.70
Centro-M EC 200 max	198	345	395	355	255	25	30	40	5.70
Centro-M EC 250	248	345	395	355	250	25	30	40	5.09
Centro-M EC 315	314	405	455	415	260	30	30	40	7.30

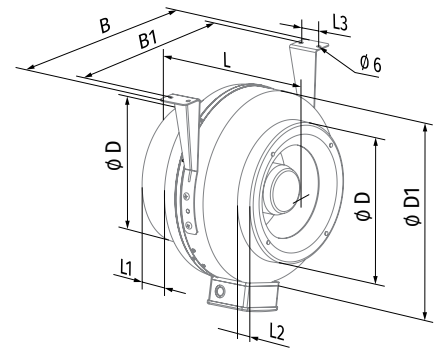

Technical data

Parameters	Centro-M EC 100	Centro-M EC 125
Voltage [V]	1 ~ 230	1 ~ 230
Frequency [Hz]	50/60	50/60
Power [W]	90	83
Current [A]	0.70	0.58
Maximum air flow [m³/h (l/s)]	345 (96)	480 (133)
RPM [min⁻¹]	3600	3400
Sound pressure at 3 m [dBA]	44	45
Transported air temperature [°C]	-25...+60	-25...+60
SEC class	B	B
IP rating	IPX4	IPX4
ErP compliance	2018	2018

CENTRO-M EC 100

Sound power level, A-weighted	Total	Octave frequency bands [Hz]								LpA 3 m	LpA 1 m
		63	125	250	500	1000	2000	4000	8000		
L _{WA} to inlet [dBA]	90	66	82	89	80	74	70	63	51	70	80
L _{WA} to outlet [dBA]	89	73	82	88	79	70	66	61	49	69	79
L _{WA} to environment [dBA]	65	31	47	56	60	59	58	47	33	44	54

CENTRO-M EC 125

Sound power level, A-weighted	Total	Octave frequency bands [Hz]								LpA 3 m	LpA 1 m
		63	125	250	500	1000	2000	4000	8000		
L _{WA} to inlet [dBA]	91	62	83	90	79	74	71	65	54	71	81
L _{WA} to outlet [dBA]	90	69	83	89	78	71	68	63	52	70	80
L _{WA} to environment [dBA]	65	27	48	58	59	60	60	49	37	45	55

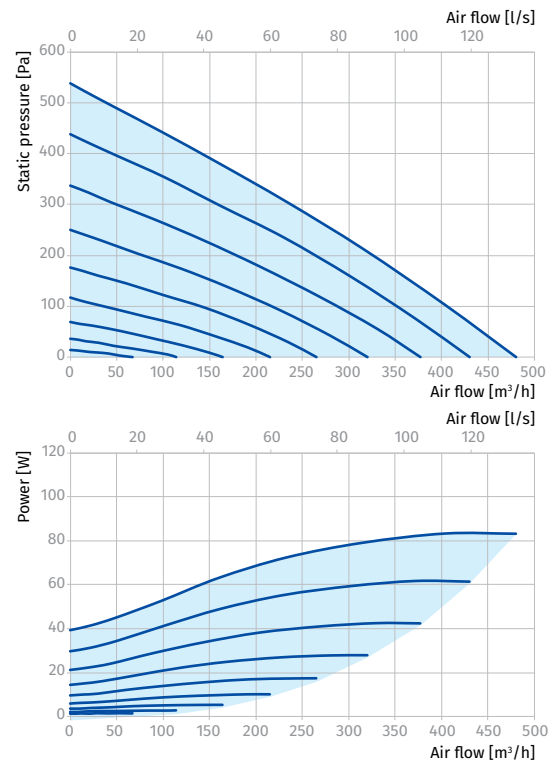
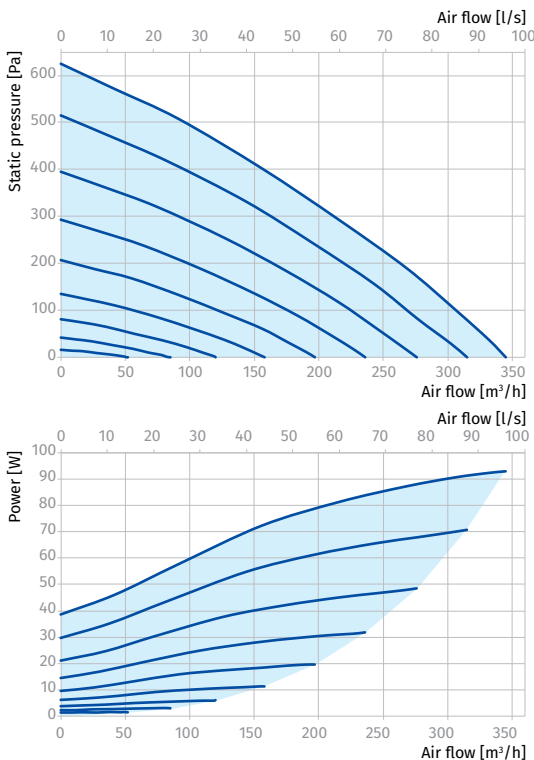

Parameters	Centro-M EC 150	Centro-M EC 160
Voltage [V]	1 ~ 230	1 ~ 230
Frequency [Hz]	50/60	50/60
Power [W]	107	108
Current [A]	0.89	0.90
Maximum air flow [m ³ /h (l/s)]	700 (194)	785 (218)
RPM [min ⁻¹]	3060	3030
Sound pressure at 3 m [dBA]	48	48
Transported air temperature [°C]	-25...+60	-25...+60
SEC class	B	B
IP rating	IPX4	IPX4
ErP compliance	2018	2018

CENTRO-M EC 150

Sound power level, A-weighted	Total	Octave frequency bands [Hz]								LpA 3 m	LpA 1 m
		63	125	250	500	1000	2000	4000	8000		
L _{WA} to inlet [dBA]	89	52	86	85	74	72	70	67	54	68	78
L _{WA} to outlet [dBA]	87	51	85	82	70	68	64	63	51	66	76
L _{WA} to environment [dBA]	69	28	50	61	64	63	62	54	41	48	58

CENTRO-M EC 160

Sound power level, A-weighted	Total	Octave frequency bands [Hz]								LpA 3 m	LpA 1 m
		63	125	250	500	1000	2000	4000	8000		
L _{WA} to inlet [dBA]	89	81	87	79	72	68	62	50	54	68	78
L _{WA} to outlet [dBA]	88	81	86	78	69	65	60	48	51	67	77
L _{WA} to environment [dBA]	69	50	59	64	63	61	50	36	41	48	58

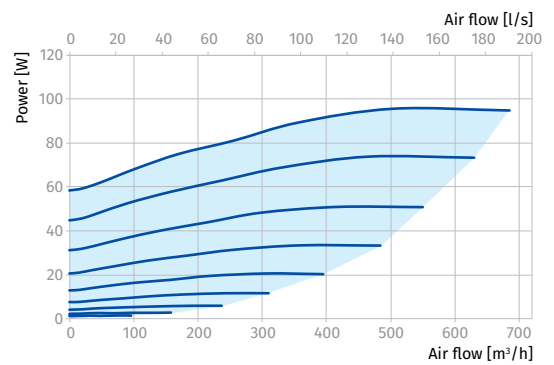
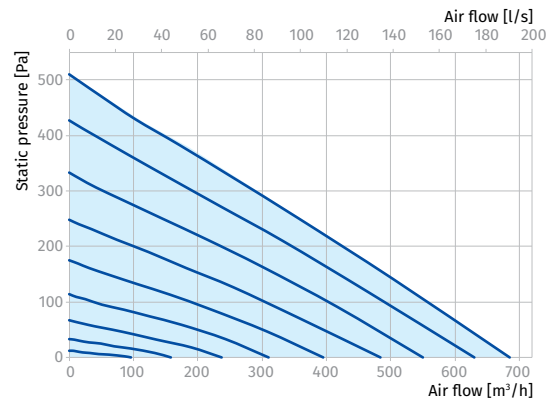
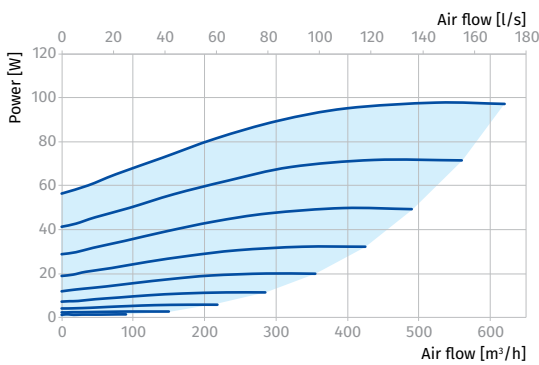
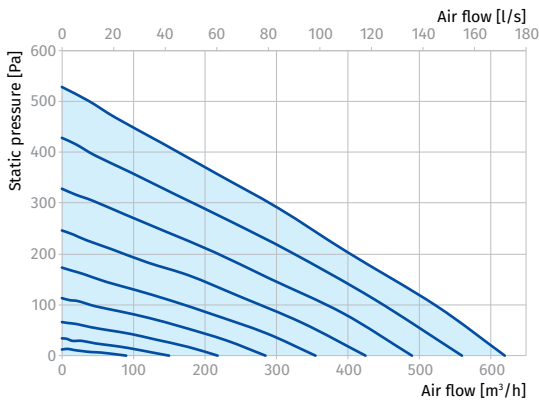

Parameters	Centro-M EC 200	Centro-M EC 200 max
Voltage [V]	1 ~ 230	1 ~ 230
Frequency [Hz]	50/60	50/60
Power [W]	83	100
Current [A]	0.63	0.74
Maximum air flow [m³/h (l/s)]	845 (235)	1010 (281)
RPM [min ⁻¹]	2500	2400
Sound pressure at 3 m [dBA]	47	48
Transported air temperature [°C]	-25...+60	-25...+60
SEC class	B	B
IP rating	IPX4	IPX4
ErP compliance	2018	2018

CENTRO-M EC 200

Sound power level, A-weighted	Total	Octave frequency bands [Hz]								LpA 3 m	LpA 1 m
		63	125	250	500	1000	2000	4000	8000		
LWA to inlet [dBA]	87	48	76	84	79	79	80	72	61	67	77
LWA to outlet [dBA]	85	45	75	79	77	77	80	72	62	64	74
LWA to environment [dBA]	67	27	49	60	62	61	60	52	39	47	57

CENTRO-M EC 200 MAX

Sound power level, A-weighted	Total	Octave frequency bands [Hz]								LpA 3 m	LpA 1 m
		63	125	250	500	1000	2000	4000	8000		
LWA to inlet [dBA]	93	63	80	88	85	87	84	79	67	72	82
LWA to outlet [dBA]	89	65	77	74	83	84	83	77	64	68	78
LWA to environment [dBA]	68	30	49	58	62	65	61	52	38	48	58

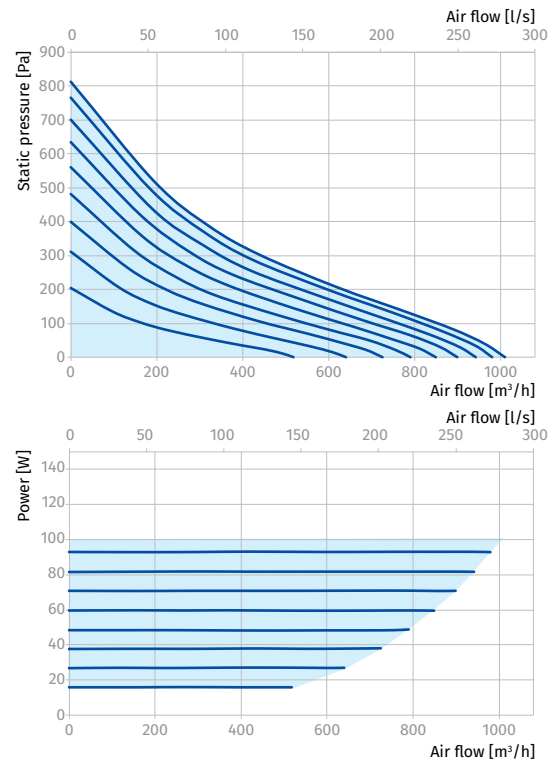
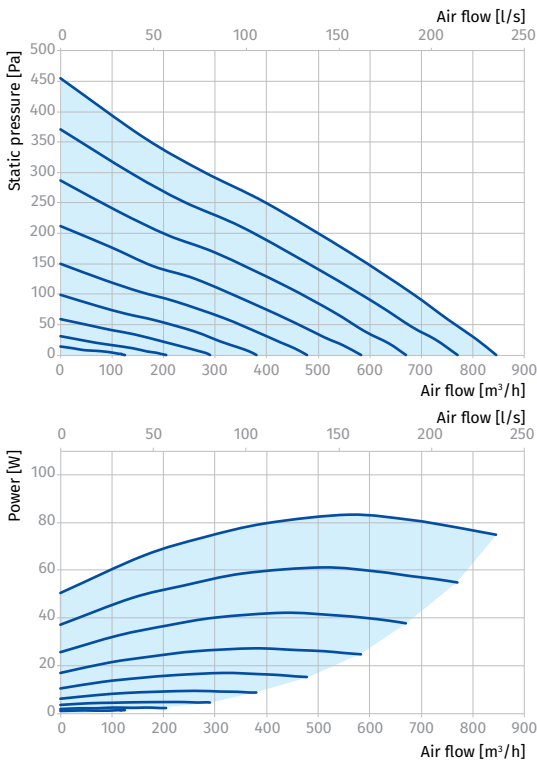

INLINE FANS

Parameters	Centro-M EC 250	Centro-M EC 315
Voltage [V]	1 ~ 230	1 ~ 230
Frequency [Hz]	50/60	50/60
Power [W]	164	164
Current [A]	1.15	1.15
Maximum air flow [m ³ /h (l/s)]	1230 (342)	1370 (381)
RPM [min ⁻¹]	2900	2900
Sound pressure at 3 m [dBA]	46	48
Transported air temperature [°C]	-25...+60	-25...+60
SEC class	-	-
IP rating	IPX4	IPX4
ErP compliance	2018	2018

CENTRO-M EC 250

Sound power level, A-weighted	Total	Octave frequency bands [Hz]								LpA 3 m	LpA 1 m
		63	125	250	500	1000	2000	4000	8000		
L _{WA} to inlet [dBA]	90	61	77	85	83	84	81	76	65	69	79
L _{WA} to outlet [dBA]	89	65	77	74	83	85	83	78	64	69	79
L _{WA} to environment [dBA]	67	29	48	57	60	63	59	51	37	46	56

CENTRO-M EC 315

Sound power level, A-weighted	Total	Octave frequency bands [Hz]								LpA 3 m	LpA 1 m
		63	125	250	500	1000	2000	4000	8000		
L _{WA} to inlet [dBA]	86	51	73	71	75	81	82	77	68	66	76
L _{WA} to outlet [dBA]	87	55	66	76	73	81	84	77	69	67	77
L _{WA} to environment [dBA]	69	30	48	56	62	64	64	56	49	48	58

