

EKH

Duct electrical heaters for round ducts

Features

- For warming up of supply air in heating, ventilation and air conditioning systems installed in various premises.
- Compatible with Ø 100 to 315 mm round air ducts.

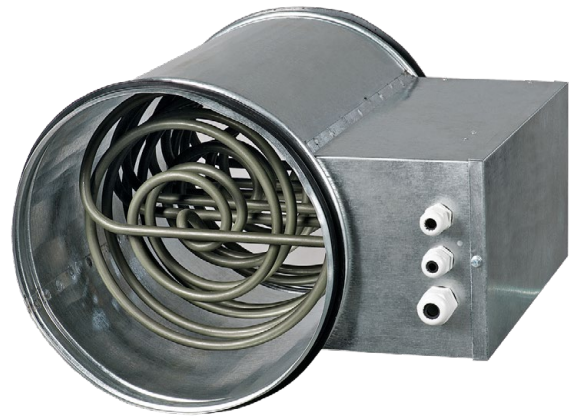

Design

- Galvanized steel case and junction box.
- Heating elements made of stainless steel.
- Airtight connection with air ducts due to rubber seals.
- Several power options for each standard size.
- For higher heating capacity several heaters may be installed in Series.
- Equipped with overheat protection thermostats:
 - basic protection with automatic restart at +50 °C;
 - emergency protection with manual restart at +90 °C.

Mounting

- Fixing to round ducts with clamps.
- Any mounting position except for the junction box downwards to prevent condensate leakage and short circuit.
- Install a filter upstream to the heater to protect heating elements against dirt ingress.

- Recommended distance between the heater and other system components must be not less than two connecting diameters for air flow stabilization.
- Duct heaters are rated for minimum air flow speed 1.5 m/s and maximum air temperature supplied to the units 40 °C. In case of speed regulation with a speed controller the minimum air speed through the heater must be provided.
- For correct and safe heater operation an automatic control and protection system is recommended including the following functions:
 - regulation of the heating capacity and temperature of the air heated up;
 - filter clogging control by a differential air pressure sensor;
 - power cut-off in case of supply fan shutdown or low air flow speed as well as in case of actuating the overheat protection thermostats;
 - heat removal from the heating elements after ventilation system shutdown.

Designation key

Series	Connected air duct diameter [mm]	Heater power [kW]
EKH	100; 125; 150; 160; 200; 250; 315	— 0.6; 0.8; 1.2; 1.6; 1.8; 2.4; 3; 3.4; 3.6; 5.1; 6; 9

Overall dimensions [mm]

Model	∅ D	B	H	L	L1
EKH 100-0.6	99	94	207	306	226
EKH 100-0.8	99	94	207	306	226
EKH 100-1.2	99	94	207	306	226
EKH 100-1.6	99	94	207	306	226
EKH 100-1.8	99	94	207	376	296
EKH 125-0.6	124	103	230	306	226
EKH 125-0.8	124	103	230	306	226
EKH 125-1.2	124	103	230	306	226
EKH 125-1.6	124	103	230	306	226
EKH 125-2.4	124	103	230	376	296
EKH 150-1.2	149	120	255	306	226
EKH 150-2.4	149	120	255	306	226
EKH 150-3.4	149	120	255	306	226
EKH 150-3.6	149	120	255	376	296
EKH 150-5.1	149	120	255	376	296
EKH 150-6	149	120	255	376	296
EKH 160-1.2	159	120	267	306	226
EKH 160-2.4	159	120	267	306	226
EKH 160-3.4	159	120	267	306	226
EKH 160-3.6	159	120	267	376	296
EKH 160-5.1	159	120	267	376	296
EKH 160-6	159	120	267	376	296
EKH 200-1.2	199	150	302	294	214
EKH 200-2.4	199	150	302	294	214
EKH 200-3.4	199	150	302	294	214
EKH 200-3.6	199	150	302	376	296
EKH 200-5.1	199	150	302	376	296
EKH 200-6	199	150	302	376	296
EKH 250-1.2	249	150	356	306	226
EKH 250-2.4	249	150	356	306	226
EKH 250-3	249	150	356	306	226
EKH 250-3.6	249	150	356	376	296
EKH 250-6	249	150	356	376	296
EKH 250-9	249	150	356	376	296
EKH 315-1.2	313	150	425	294	214
EKH 315-2.4	313	150	425	294	214
EKH 315-3.6	313	150	425	376	296
EKH 315-6	313	150	425	376	296
EKH 315-9	313	150	425	376	296

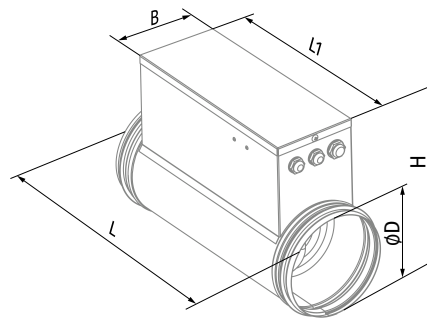

Technical data

Model	Minimum air flow [m³/h (l/s)]	Current [A]	Voltage [V]	Power [kW]	Number of heating coils x capacity [kW]	Phase	Weight [kg]
EKH 100-0.6	60 (17)	2.6	230	0.6	1x0.6	1	2.6
EKH 100-0.8	80 (22)	3.5	230	0.8	1x0.8	1	2.6
EKH 100-1.2	90 (25)	5.2	230	1.2	2x0.6	1	2.9
EKH 100-1.6	120 (33)	7.0	230	1.6	2x0.8	1	2.9
EKH 100-1.8	130 (36)	7.8	230	1.8	3x0.6	1	3.1
EKH 125-0.6	60 (17)	2.6	230	0.6	1x0.6	1	2.4
EKH 125-0.8	80 (22)	3.5	230	0.8	1x0.8	1	2.4
EKH 125-1.2	90 (25)	5.2	230	1.2	2x0.6	1	2.7
EKH 125-1.6	120 (33)	7.0	230	1.6	2x0.8	1	2.7
EKH 125-2.4	150 (42)	7.8	230	2.4	3x0.8	1	3.0
EKH 150-1.2	120 (33)	5.2	230	1.2	1x1.2	1	2.5
EKH 150-2.4	150 (42)	10.4	230	2.4	2x1.2	1	3.1
EKH 150-3.4	220 (61)	14.7	230	3.4	2x1.7	1	3.1
EKH 150-3.6	265 (74)	5.2	400	3.6	3x1.2	3	4.1
EKH 150-5.1	320 (89)	7.4	400	5.1	3x1.7	3	4.1
EKH 150-6	360 (100)	8.7	400	6.0	3x2.0	3	4.1
EKH 160-1.2	150 (42)	5.2	230	1.2	1x1.2	1	2.1
EKH 160-2.4	180 (50)	10.4	230	2.4	2x1.2	1	2.9
EKH 160-3.4	250 (69)	14.8	230	3.4	2x1.7	1	3.2
EKH 160-3.6	265 (74)	5.2	400	3.6	3x1.2	3	3.9
EKH 160-5.1	375 (104)	7.4	400	5.1	3x1.7	3	3.9
EKH 160-6	440 (122)	8.7	400	6.0	3x2.0	3	3.9
EKH 200-1.2	150 (42)	5.2	230	1.2	1x1.2	1	2.4
EKH 200-2.4	180 (50)	10.4	230	2.4	2x1.2	1	3.2
EKH 200-3.4	250 (69)	14.8	230	3.4	2x1.7	1	3.3
EKH 200-3.6	265 (74)	5.2	400	3.6	3x1.2	3	4.1
EKH 200-5.1	375 (104)	7.4	400	5.1	3x1.7	3	4.1
EKH 200-6	440 (122)	8.7	400	6.0	3x2.0	3	4.1
EKH 250-1.2	180 (50)	5.2	230	1.2	1x1.2	1	2.4
EKH 250-2.4	180 (50)	10.4	230	2.4	2x1.2	1	2.6
EKH 250-3	375 (104)	13.0	230	3.0	1x3.0	1	2.4
EKH 250-3.6	375 (104)	5.2	400	3.6	3x1.2	3	2.9
EKH 250-6	440 (122)	8.7	400	6.0	3x2.0	3	2.9
EKH 250-9	660 (183)	13.0	400	9.0	3x3.0	3	2.9
EKH 315-1.2	180 (50)	5.2	230	1.2	1x1.2	1	2.6
EKH 315-2.4	265 (74)	10.4	230	2.4	2x1.2	1	2.8
EKH 315-3.6	375 (104)	5.2	400	3.6	3x1.2	3	3.1
EKH 315-6	440 (122)	8.7	400	6.0	3x2.0	3	3.1
EKH 315-9	660 (183)	13.0	400	9.0	3x3.0	3	3.1

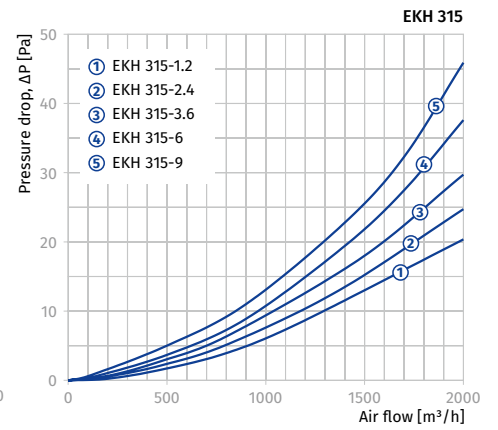
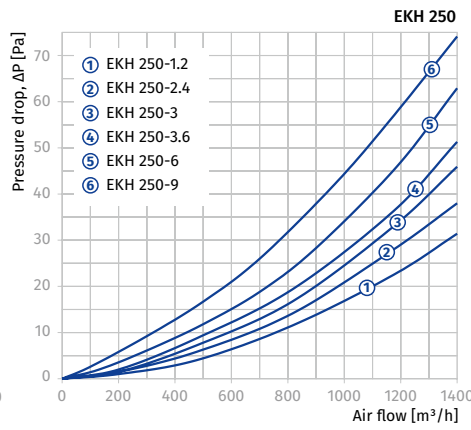
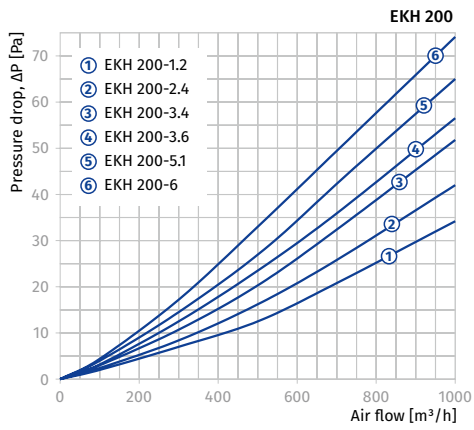
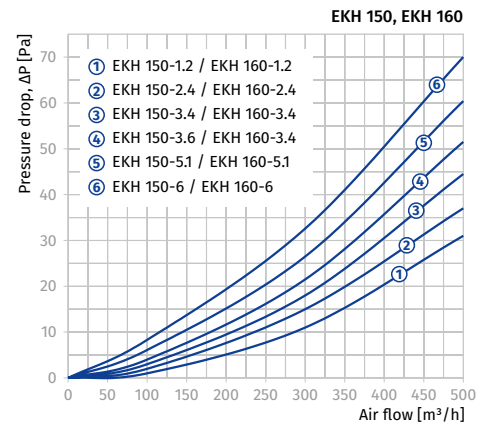
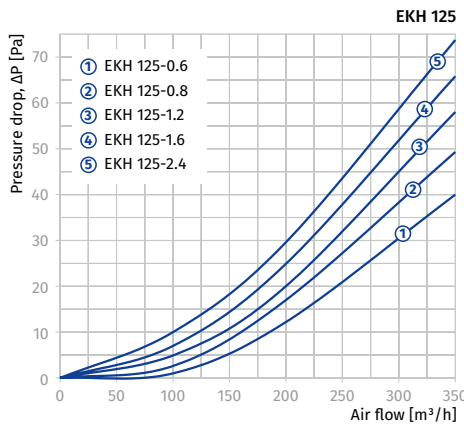
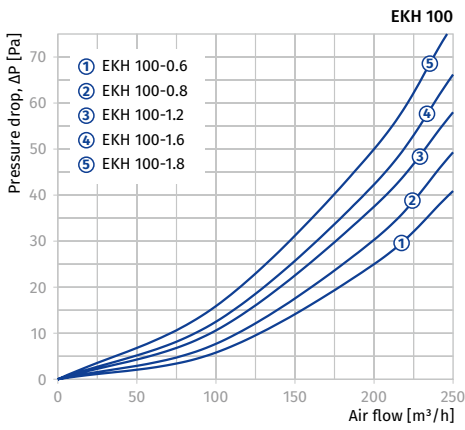

Air temperature increase as a function of air flow

