

Iso-B

Sound-insulated inline centrifugal fans

Use

- Supply and extract ventilation systems installed in premises with high requirements to the noise level.
- Suitable for limited mounting space.
- Compatible with Ø 100 up to 315 mm round air ducts.



Air flow:
up to 2150 m³/h
597 l/s



Power:
from 72 W



Noise level:
from 33 dBA

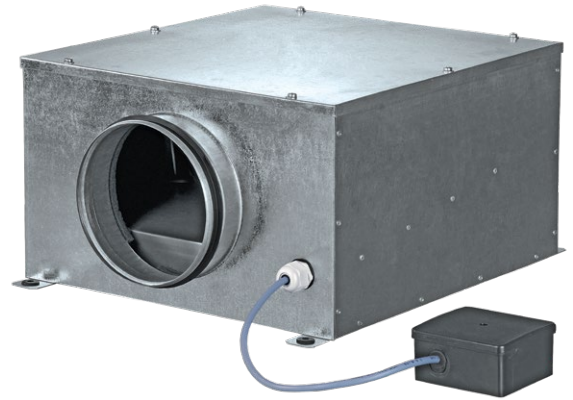

Design

- Galvanized steel casing internally filled with 30 mm thermal- and sound-insulating layer made of non-flammable foamed polyurethane.
- The connection spigots are equipped with rubber seals.
- Fixing brackets for easy mounting.

Motor

- Two-pole external rotor asynchronous motor with centrifugal impeller and backward curved blades.
- The motor is installed on specially designed vibration-damping mounts to absorb vibration and noise.
- Equipped with ball bearings for longer service life.
- Integrated thermal protection with automatic restart.
- Dynamically balanced impeller.

Speed control

- Smooth speed control with an external thyristor controller or step speed control with an external auto transformer (both available upon separate order).

Mounting

- Fixed to wall or ceiling with a fixing bracket supplied as a standard.
- Flexible air ducts are fixed on the fan spigots with clamps.
- Power is supplied through an external terminal box.

Modifications and options

- max:** high-powered motor.
- G1:** speed controller, temperature controller with external temperature sensor (cable length 4 m), power cable with mains plug.
- G11:** speed controller, temperature controller with integrated temperature sensor and power cable with mains plug.
- The **G1** and **G11** modifications enable automatic speed control depending on indoor temperature. The optimal ventilation solution for premises requiring permanent temperature control as greenhouses, orangeries, etc.
- W1:** power cable with mains plug.

SOUND-INSULATED FANS

Designation key

Series	Spigot diameter [mm]	Motor modifications	Options
Iso-B	100; 125; 150; 160; 200; 250; 315	max: high-powered motor	G1: speed controller, temperature controller with external temperature sensor, power cable with mains plug G11: speed controller, temperature controller with integrated temperature sensor and power cable mains plug W1: power cable with mains plug

Accessories

Silencers	Filter boxes	Electric heaters	Water heaters	Backdraft air dampers	Air dampers	Speed controllers	Timers/Sensors
 SD	 KFBK / KFBT	 EKH	 WKH	 VRV	 VK / VKA	 CDT E1.8	 TE(TI) / HSE(HSI) / LSE(LSI) / IRSE(IRSI)

Overall dimensions [mm]

Type	Ø D	B	B1	H	L	L1	L2	Weight [kg]
Iso-B 100	99	322	280	192	447	380	350	5.4
Iso-B 125	124	322	280	192	447	380	350	5.4
Iso-B 150	149	352	310	212	477	410	380	6.4
Iso-B 160	159	352	310	212	477	410	380	6.4
Iso-B 200	199	432	368	287	588	506	480	10.0
Iso-B 200 max	199	432	368	287	588	506	480	12.0
Iso-B 250	249	432	368	287	588	506	480	12.5
Iso-B 315	314	502	438	397	648	566	540	15.5

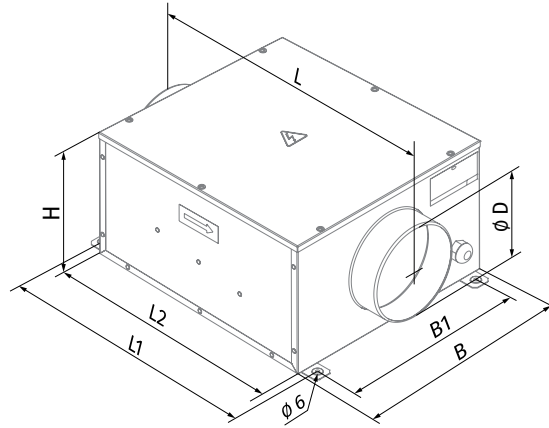

Technical data

Parameters	Iso-B 100		Iso-B 125		Iso-B 150		Iso-B 160	
Voltage [V]	1 ~ 230		1 ~ 230		1 ~ 230		1 ~ 230	
Frequency [Hz]	50	60	50	60	50	60	50	60
Power [W]	73	77	73	77	72	76	75	76
Current [A]	0.32	0.34	0.32	0.34	0.32	0.33	0.33	0.33
Maximum air flow [m ³ /h (l/s)]	240 (67)	255 (71)	330 (92)	345 (96)	420 (117)	435 (121)	420 (117)	435 (121)
RPM [min ⁻¹]	2560	2690	2590	2700	2600	2720	2690	2720
Sound pressure at 3 m [dBA]	33	34	35	36	36	37	36	37
Transported air temperature [°C]	-25...+55		-25...+55		-25...+55		-25...+55	
SEC class	C		C		C		C	
IP rating	IPX4		IPX4		IPX4		IPX4	
Motor IP rating	IP44		IP44		IP44		IP44	
ErP	2018		2018		2018		2018	

ISO-B 100

Sound power level, A-weighted	Total	Octave frequency bands [Hz]							
		63	125	250	500	1000	2000	4000	8000
L _{WA} to inlet [dBA]	59	53	57	54	52	51	54	51	47
L _{WA} to outlet [dBA]	68	49	50	53	56	66	63	56	54
L _{WA} to environment [dBA]	40	27	29	32	31	34	29	29	20

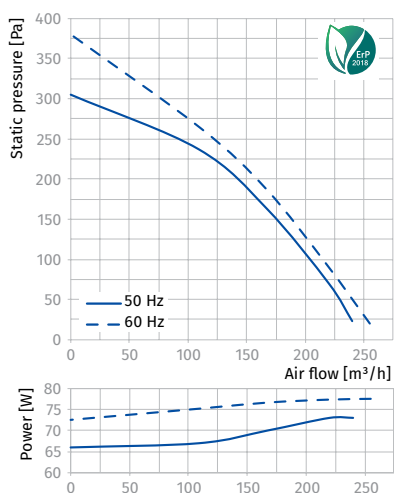

ISO-B 125

Sound power level, A-weighted	Total	Octave frequency bands [Hz]							
		63	125	250	500	1000	2000	4000	8000
L _{WA} to inlet [dBA]	64	51	51	54	56	54	55	53	51
L _{WA} to outlet [dBA]	65	50	49	59	55	61	61	58	51
L _{WA} to environment [dBA]	38	29	32	33	33	33	31	28	25

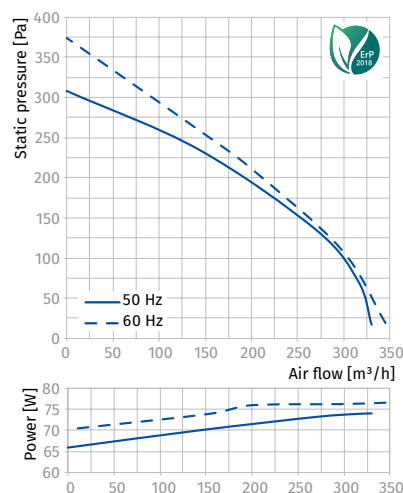

ISO-B 150

Sound power level, A-weighted	Total	Octave frequency bands [Hz]							
		63	125	250	500	1000	2000	4000	8000
L _{WA} to inlet [dBA]	62	49	50	58	56	54	55	52	50
L _{WA} to outlet [dBA]	66	43	44	59	55	62	60	55	53
L _{WA} to environment [dBA]	41	26	30	35	34	34	30	26	25

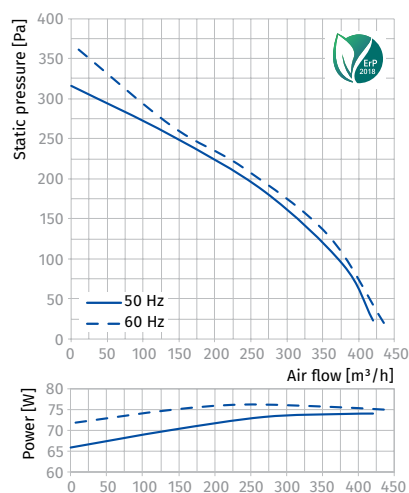

ISO-B 160

Sound power level, A-weighted	Total	Octave frequency bands [Hz]							
		63	125	250	500	1000	2000	4000	8000
L _{WA} to inlet [dBA]	62	50	51	60	56	52	55	54	51
L _{WA} to outlet [dBA]	68	48	47	57	60	67	63	59	56
L _{WA} to environment [dBA]	41	28	26	32	33	36	34	25	23

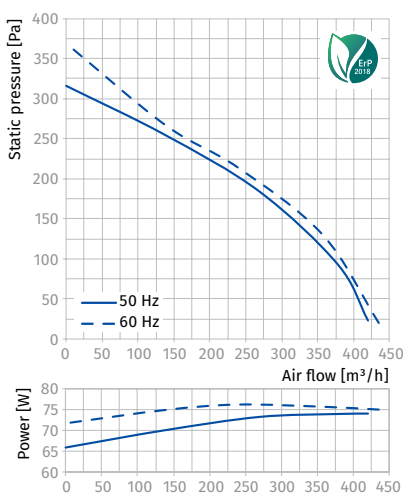

Parameters	Iso-B 200		Iso-B 200 max		Iso-B 250		Iso-B 315	
Voltage [V]	1 ~ 230		1 ~ 230		1 ~ 230		1 ~ 230	
Frequency [Hz]	50	60	50	60	50	60	50	60
Power [W]	103	122	195	232	198	238	322	367
Current [A]	0.45	0.53	0.85	1.02	0.87	1.04	1.4	1.6
Maximum air flow [m³/h (l/s)]	730 (203)	750 (208)	950 (264)	960 (267)	1300 (361)	1315 (365)	2150 (597)	2150 (597)
RPM [min⁻¹]	2550	2740	2570	2690	2420	2730	2670	2850
Sound pressure at 3 m [dBA]	38	39	41	42	41	43	43	44
Transported air temperature [°C]	-25...+50	-25...+45	-25...+45	-25...+45	-25...+50	-25...+45	-25...+45	-25...+45
SEC class	B		B		-		-	
IP rating	IPX4		IPX4		IPX4		IPX4	
Motor IP rating	IP44		IP44		IP44		IP44	
ErP	2018		2018		-		-	

ISO-B 200

Sound power level, A-weighted	Total	Octave frequency bands [Hz]							
		63	125	250	500	1000	2000	4000	8000
LWA to inlet [dBA]	52	37	38	45	45	39	39	36	26
LWA to outlet [dBA]	67	49	46	55	64	59	60	53	41
LWA to environment [dBA]	43	33	35	33	38	25	31	25	25

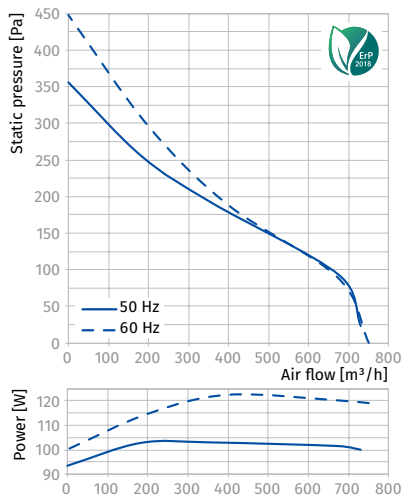

ISO-B 200 MAX

Sound power level, A-weighted	Total	Octave frequency bands [Hz]							
		63	125	250	500	1000	2000	4000	8000
LWA to inlet [dBA]	53	41	43	53	51	47	44	44	36
LWA to outlet [dBA]	70	48	49	57	68	65	63	58	51
LWA to environment [dBA]	45	29	32	37	40	27	29	26	27

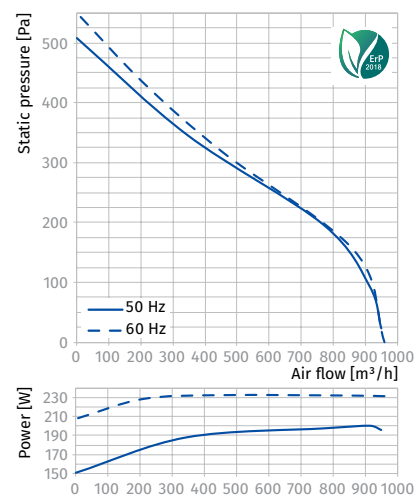

ISO-B 250

Sound power level, A-weighted	Total	Octave frequency bands [Hz]							
		63	125	250	500	1000	2000	4000	8000
LWA to inlet [dBA]	59	44	45	54	51	47	45	45	38
LWA to outlet [dBA]	74	51	51	62	70	67	64	61	55
LWA to environment [dBA]	46	33	36	41	42	30	26	23	27

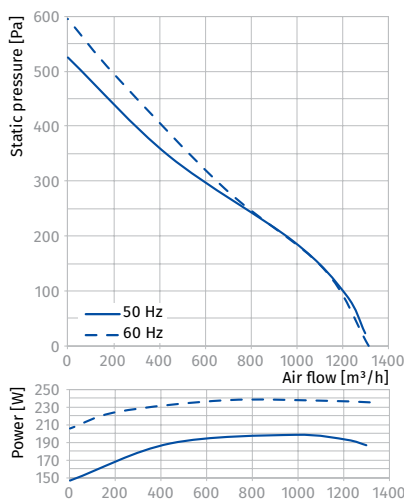

ISO-B 315

Sound power level, A-weighted	Total	Octave frequency bands [Hz]							
		63	125	250	500	1000	2000	4000	8000
LWA to inlet [dBA]	59	45	47	56	47	48	50	44	40
LWA to outlet [dBA]	75	52	51	59	68	68	65	62	54
LWA to environment [dBA]	48	41	41	44	43	36	28	32	29

