

Iso Box-F (V2)

Sound-insulated centrifugal fans with filters

Use

- Supply ventilation systems installed in premises with high requirements to clean air and the noise level.
- Suitable for limited mounting space.
- Compatible with Ø 100 up to 200 mm round air ducts.



Air flow:
up to 630 m³/h
175 l/s



Power:
from 32 W



Noise level:
from 14 dBA

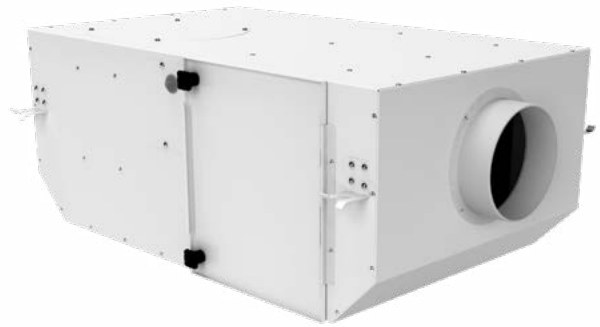

Design

- The casing is made of polymer-coated steel, internally filled with sound-insulating layer.
- Internal airtight terminal box for power supply.
- Easy access for filter maintenance.

Motors

- Iso Box-F** series: four-pole asynchronous motor with external rotor and centrifugal impeller with forward curved blades.
- Iso Box-F V2** series: two-speed asynchronous motor with external rotor and centrifugal impeller with forward curved blades.
- Equipped with ball bearings for longer service life.
- Integrated thermal protection with automatic restart.
- Dynamically balanced impeller.

Speed control

- Iso Box-F** series: Smooth speed control with an external **CDT E1.8** thyristor controller (available upon separate order).
- Iso Box-F V2** series: Two-speed control with the external **CDP-2/10** speed switch (available upon separate order).

Mounting

- Due to compact design is the ideal solution for mounting in limited spaces, including the space behind false ceiling.
- Any mounting position.
- Wall or ceiling mounting with fixing brackets supplied as a standard.

Air filtration

- Built-in filters provide efficient air filtration. Up to three filters can be installed into the fan.
- G4** filter provides primary filtration. At the second stage, the secondary filter **F8** or **HEPA** filter **H13** can be installed. **F8** filter arrests up to 98 % of PM2.5 dust particles. **H13** filter arrest up to 99 % of PM2.5 dust particles, pollen and bacteria. For additional removal of odors and gases carbon filter can be installed.
- Quick access to replaceable filters through service panel.

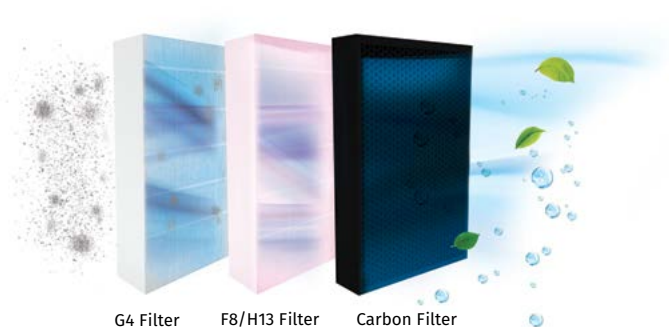

G4 Filter F8/H13 Filter Carbon Filter

Designation key

Series	Duct diameter [mm]	Filters	Motor modification	Speed
Iso Box-F	100; 150; 200	G4; G4-F8; G4-F8-Carbon; G4-H13; G4-H13-Carbon	┆: standard Model L: low-powered motor	┆: one speed V2: two-speed

Accessories

Air disc valves	Duct system	Flexible air ducts	Grilles and hoods	Speed controllers	Clamps
VPR / VSR / VMR	BlauPlast	BlauFlex	Decor / GM	CDT E1.8 / CDP-2/10	K / KZ

Replaceable filters

		Iso Box-F 100 (V2)	Iso Box-F 150 (V2)	Iso Box-F 150 L (V2)	Iso Box-F 200 (V2)
G4 Panel filter		FP 220x400x47 G4	FP 270x425x47 G4	FP 220x400x47 G4	FP 270x590x47 G4
F8 Panel filter		FP 220x400x47 F8	FP 270x425x47 F8	FP 220x400x47 F8	FP 270x590x47 F8
H13 Panel filter		FP 220x400x47 H13	FP 270x425x47 H13	FP 220x400x47 H13	FP 270x590x47 H13
Carbon panel filter		FP 220x400x47 C	FP 270x425x47 C	FP 220x400x47 C	FP 270x590x47 C

Overall dimensions [mm]

Model	Ø D	L	H	B	L1	B1	L2	B2	Weight [kg]
Iso Box-F 100 G4 (V2)	100	705	250	415	805	508	650	458	13.95
Iso Box-F 100 G4-F8 (V2)	100	705	250	415	805	508	650	458	14.16
Iso Box-F 100 G4-F8-Carbon (V2)	100	705	250	415	805	508	650	458	14.86
Iso Box-F 100 G4-H13 (V2)	100	705	250	415	805	508	650	458	14.16
Iso Box-F 100 G4-H13-Carbon (V2)	100	705	250	415	805	508	650	458	14.86
Iso Box-F 150 G4 (V2)	150	735	300	440	835	533	680	483	15.92
Iso Box-F 150 G4-F8 (V2)	150	735	300	440	835	533	680	483	16.17
Iso Box-F 150 G4-F8-Carbon (V2)	150	735	300	440	835	533	680	483	17.08
Iso Box-F 150 G4-H13 (V2)	150	735	300	440	835	533	680	483	16.17
Iso Box-F 150 G4-H13-Carbon (V2)	150	735	300	440	835	533	680	483	17.08
Iso Box-F 150 G4 L (V2)	150	705	250	415	805	508	650	458	13.96
Iso Box-F 150 G4-F8 L (V2)	150	705	250	415	805	508	650	458	14.17
Iso Box-F 150 G4-F8-Carbon L (V2)	150	705	250	415	805	508	650	458	14.87
Iso Box-F 150 G4-H13 L (V2)	150	705	250	415	805	508	650	458	14.17
Iso Box-F 150 G4-H13-Carbon L (V2)	150	705	250	415	805	508	650	458	14.87
Iso Box-F 200 G4 (V2)	200	735	300	605	835	698	680	648	18.72
Iso Box-F 200 G4-F8 (V2)	200	735	300	605	835	698	680	648	19.10
Iso Box-F 200 G4-F8-Carbon (V2)	200	735	300	605	835	698	680	648	20.32
Iso Box-F 200 G4-H13 (V2)	200	735	300	605	835	698	680	648	19.10
Iso Box-F 200 G4-H13-Carbon (V2)	200	735	300	605	835	698	680	648	20.32

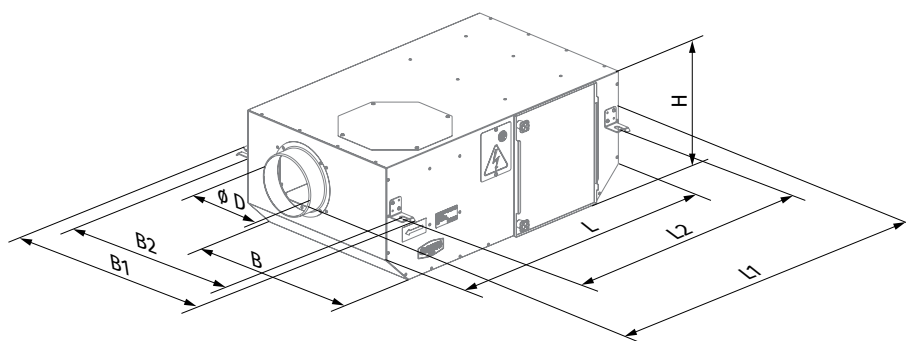

Technical data

Parameters	Iso Box-F 100 G4 Iso Box-F 100 G4-Carbon	Iso Box-F 100 G4-F8 Iso Box-F 100 G4-F8-Carbon	Iso Box-F 100 G4-H13 Iso Box-F 100 G4-H13-Carbon
Voltage [V]	1 ~ 230	1 ~ 230	1 ~ 230
Frequency [Hz]	50/60	50/60	50/60
Power [W]	53	53	52
Current [A]	0.27	0.27	0.27
Maximum air flow [m ³ /h (l/s)]	190 (53)	180 (50)	170 (47)
RPM [min ⁻¹]	1300	1300	1300
Sound pressure at 3 m [dBA]	23	23	23
Transported air temperature [°C]	-25...+40	-25...+40	-25...+40
IP rating	IPX4	IPX4	IPX4
PM2.5 Ratio [%]	36	93	98
SEC class	D	D	D
ErP	2018	2018	2018

ISO BOX-F 100

Sound power level, A-weighted	Total	Octave frequency bands [Hz]								LpA 3 m [dBA]	LpA 1 m [dBA]
		63	125	250	500	1000	2000	4000	8000		
L _{WA} to inlet [dBA]	48	32	34	40	42	43	40	34	26	27	37
L _{WA} to outlet [dBA]	51	27	42	47	45	44	32	24	13	30	40
L _{WA} to environment [dBA]	43	31	34	35	38	36	34	31	26	23	33

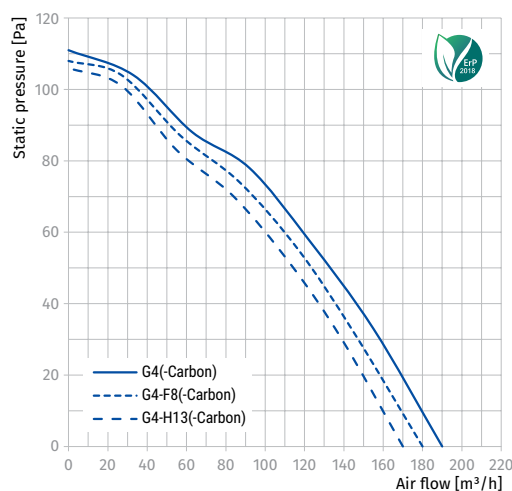

Parameters	Iso Box-F 150 G4 L Iso Box-F 150 G4-Carbon L	Iso Box-F 150 G4-F8 L Iso Box-F 150 G4-F8-Carbon L	Iso Box-F 150 G4-H13 L Iso Box-F 150 G4-H13-Carbon L
Voltage [V]	1 ~ 230	1 ~ 230	1 ~ 230
Frequency [Hz]	50/60	50/60	50/60
Power [W]	63	61	59
Current [A]	0.29	0.25	0.28
Maximum air flow [m³/h (l/s)]	360 (100)	330 (92)	310 (86)
RPM [min ⁻¹]	1300	1300	1300
Sound pressure at 3 m [dBA]	25	25	25
Transported air temperature [°C]	-25..+40	-25..+40	-25..+40
IP rating	IPX4	IPX4	IPX4
PM2.5 Ratio [%]	31	92	98
SEC class	C	C	C
ErP	-	-	2018

ISO BOX-F 150 L

Sound power level, A-weighted	Total	Octave frequency bands [Hz]								LpA 3 m [dBA]	LpA 1 m [dBA]
		63	125	250	500	1000	2000	4000	8000		
L _{WA} to inlet [dBA]	53	28	44	49	47	46	34	25	14	33	43
L _{WA} to outlet [dBA]	56	39	41	48	51	52	48	41	32	36	46
L _{WA} to environment [dBA]	45	26	35	41	39	37	34	30	23	25	35

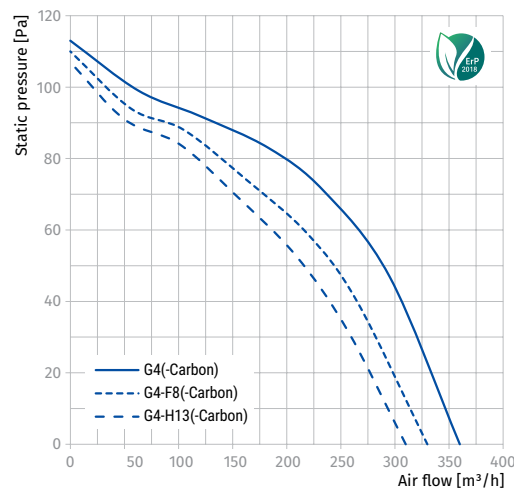

Parameters	Iso Box-F 150 G4 Iso Box-F 150 G4-Carbon	Iso Box-F 150 G4-F8 Iso Box-F 150 G4-F8-Carbon	Iso Box-F 150 G4-H13 Iso Box-F 150 G4-H13-Carbon
Voltage [V]	1 ~ 230	1 ~ 230	1 ~ 230
Frequency [Hz]	50/60	50/60	50/60
Power [W]	107	104	102
Current [A]	0.49	0.48	0.48
Maximum air flow [m ³ /h (l/s)]	440 (122)	400 (111)	360 (100)
RPM [min ⁻¹]	1250	1250	1250
Sound pressure at 3 m [dBA]	27	27	27
Transported air temperature [°C]	-25..+40	-25..+40	-25..+40
IP rating	IPX4	IPX4	IPX4
PM2.5 Ratio [%]	39	92	98
SEC class	C	C	D
ErP	2018	2018	2018

ISO BOX-F 150

Sound power level, A-weighted	Total	Octave frequency bands [Hz]								LpA 3 m [dBA]	LpA 1 m [dBA]
		63	125	250	500	1000	2000	4000	8000		
L _{WA} to inlet [dBA]	53	39	40	47	50	41	40	38	27	33	43
L _{WA} to outlet [dBA]	58	42	39	47	54	50	51	45	35	37	47
L _{WA} to environment [dBA]	48	38	40	41	44	36	29	28	24	27	37

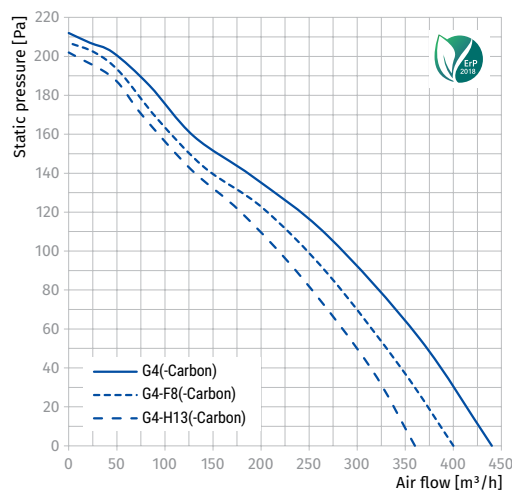

Parameters	Iso Box-F 200 G4 Iso Box-F 200 G4-Carbon	Iso Box-F 200 G4-F8 Iso Box-F 200 G4-F8-Carbon	Iso Box-F 200 G4-H13 Iso Box-F 200 G4-H13-Carbon
Voltage [V]	1 ~ 230	1 ~ 230	1 ~ 230
Frequency [Hz]	50/60	50/60	50/60
Power [W]	123	120	115
Current [A]	0.56	0.56	0.52
Maximum air flow [m³/h (l/s)]	580 (161)	570 (158)	490 (136)
RPM [min ⁻¹]	1250	1250	1250
Sound pressure at 3 m [dBA]	38	38	38
Transported air temperature [°C]	-25..+40	-25..+40	-25..+40
IP rating	IPX4	IPX4	IPX4
PM2.5 Ratio [%]	40	93	98
SEC class	C	C	C
ErP	2018	2018	2018

ISO BOX-F 200

Sound power level, A-weighted	Total	Octave frequency bands [Hz]								LpA 3 m [dBA]	LpA 1 m [dBA]
		63	125	250	500	1000	2000	4000	8000		
L _{WA} to inlet [dBA]	67	55	56	58	60	58	59	57	55	46	56
L _{WA} to outlet [dBA]	71	58	56	68	63	61	59	55	47	50	60
L _{WA} to environment [dBA]	58	44	48	54	55	40	34	30	36	38	48

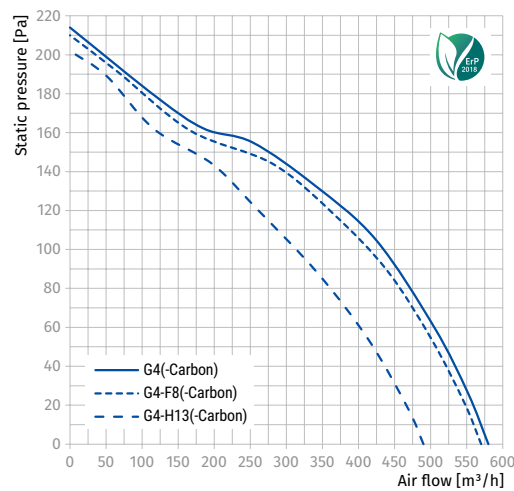

Parameters	Iso Box-F 100 G4 V2 Iso Box-F 100 G4-Carbon V2		Iso Box-F 100 G4-F8 V2 Iso Box-F 100 G4-F8-Carbon V2		Iso Box-F 100 G4-H13 V2 Iso Box-F 100 G4-H13-Carbon V2	
	min	max	min	max	min	max
Speed						
Voltage [V]	1 ~ 230		1 ~ 230		1 ~ 230	
Frequency [Hz]	50		50		50	
Power [W]	34	42	33	41	32	41
Current [A]	0.15	0.19	0.15	0.19	0.15	0.19
Maximum air flow [m³/h (l/s)]	160 (44)	190 (53)	150 (42)	175 (49)	140 (39)	160 (44)
RPM [min ⁻¹]	700	1200	700	1200	700	1200
Sound pressure at 3 m [dBA]	14	23	14	23	14	23
Transported air temperature [°C]	-25..+40		-25..+40		-25..+40	
IP rating	IPX4		IPX4		IPX4	
PM2.5 Ratio [%]	35	31	94	93	99	98
SEC class	D		E		E	
ErP	2018		-		-	

ISO BOX-F 100 V2

Sound power level, A-weighted	Total	Octave frequency bands [Hz]								LpA 3 m [dBA]	LpA 1 m [dBA]	
		63	125	250	500	1000	2000	4000	8000			
min	L _{WA} to inlet [dBA]	41	26	28	33	35	36	33	28	22	20	30
	L _{WA} to outlet [dBA]	43	22	35	39	37	37	27	20	11	23	33
	L _{WA} to environment [dBA]	35	23	26	26	29	27	26	23	20	14	24
max	L _{WA} to inlet [dBA]	48	32	34	40	42	43	40	34	26	27	37
	L _{WA} to outlet [dBA]	51	27	42	47	45	44	32	24	13	30	40
	L _{WA} to environment [dBA]	43	31	34	35	38	36	34	31	26	23	33

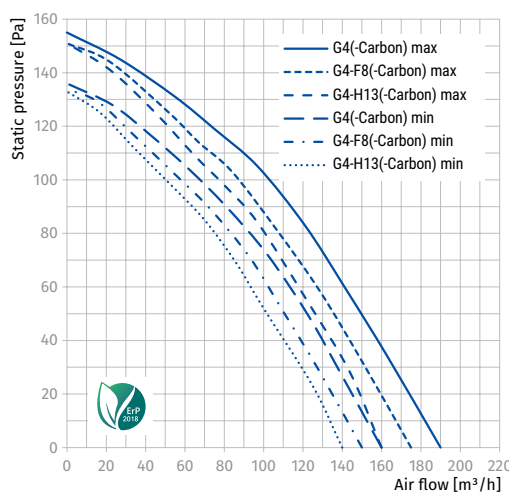

Parameters	Iso Box-F 150 G4 L V2 Iso Box-F 150 G4-Carbon L V2		Iso Box-F 150 G4-F8 L V2 Iso Box-F 150 G4-F8-Carbon L V2		Iso Box-F 150 G4-H13 L V2 Iso Box-F 150 G4-H13-Carbon L V2	
	min	max	min	max	min	max
Speed						
Voltage [V]	1 ~ 230		1 ~ 230		1 ~ 230	
Frequency [Hz]	50		50		50	
Power [W]	44	52	41	50	40	48
Current [A]	0.19	0.23	0.18	0.22	0.18	0.21
Maximum air flow [m³/h (l/s)]	230 (64)	340 (94)	215 (60)	310 (86)	205 (57)	285 (79)
RPM [min⁻¹]	700	1200	700	1200	700	1200
Sound pressure at 3 m [dBA]	15	25	15	25	15	25
Transported air temperature [°C]	-25..+40		-25..+40		-25..+40	
IP rating	IPX4		IPX4		IPX4	
PM2.5 Ratio [%]	31	23	90	87	93	92
SEC class	C		C		D	
ErP	2018		2018		2018	

ISO BOX-F 150 L V2

Sound power level, A-weighted	Total	Octave frequency bands [Hz]								LpA 3 m [dBA]	LpA 1 m [dBA]	
		63	125	250	500	1000	2000	4000	8000			
min	LWA to inlet [dBA]	45	24	37	41	39	38	28	21	11	25	35
	LWA to outlet [dBA]	48	32	34	40	42	43	40	34	26	27	37
	LWA to environment [dBA]	36	20	26	31	29	28	26	23	17	15	25
max	LWA to inlet [dBA]	53	28	44	49	47	46	34	25	14	33	43
	LWA to outlet [dBA]	56	39	41	48	51	52	48	41	32	36	46
	LWA to environment [dBA]	45	26	35	41	39	37	34	30	23	25	35

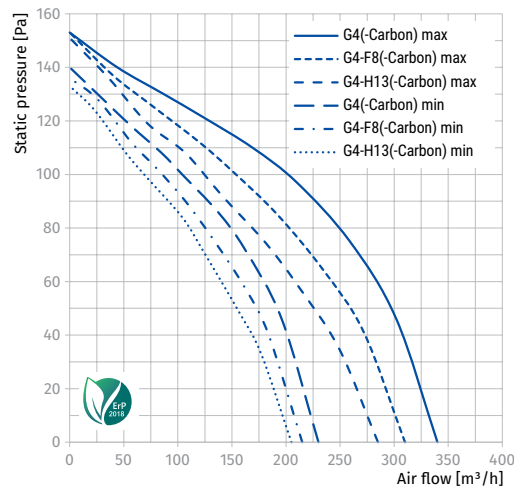

Parameters	Iso Box-F 150 G4 V2 Iso Box-F 150 G4-Carbon V2		Iso Box-F 150 G4-F8 V2 Iso Box-F 150 G4-F8-Carbon V2		Iso Box-F 150 G4-H13 V2 Iso Box-F 150 G4-H13-Carbon V2	
	min	max	min	max	min	max
Speed						
Voltage [V]	1 ~ 230		1 ~ 230		1 ~ 230	
Frequency [Hz]	50		50		50	
Power [W]	92	117	89	115	85	114
Current [A]	0.41	0.55	0.41	0.55	0.38	0.54
Maximum air flow [m³/h (l/s)]	320 (89)	430 (119)	300 (83)	390 (108)	280 (78)	355 (99)
RPM [min ⁻¹]	700	1200	700	1200	700	1200
Sound pressure at 3 m [dBA]	16	27	16	27	16	27
Transported air temperature [°C]	-25...+40		-25...+40		-25...+40	
IP rating	IPX4		IPX4		IPX4	
PM2.5 Ratio [%]	47	41	95	94	98	96
SEC class	D		C		E	
ErP	2018		2018		-	

ISO BOX-F 150 V2

Sound power level, A-weighted	Total	Octave frequency bands [Hz]								LpA 3 m [dBA]	LpA 1 m [dBA]	
		63	125	250	500	1000	2000	4000	8000			
min	L _{WA} to inlet [dBA]	44	31	32	38	41	33	32	31	22	24	34
	L _{WA} to outlet [dBA]	48	34	32	38	44	41	41	36	28	28	38
	L _{WA} to environment [dBA]	36	27	29	30	32	26	21	20	17	16	26
max	L _{WA} to inlet [dBA]	53	39	40	47	50	41	40	38	27	33	43
	L _{WA} to outlet [dBA]	58	42	39	47	54	50	51	45	35	37	47
	L _{WA} to environment [dBA]	48	38	40	41	44	36	29	28	24	27	37

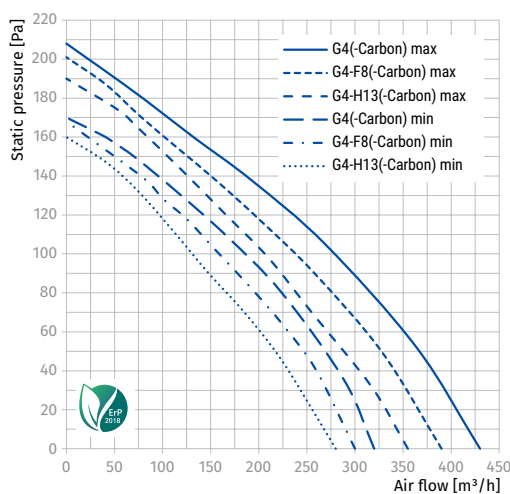

Parameters	Iso Box-F 200 G4 V2 Iso Box-F 200 G4-Carbon V2		Iso Box-F 200 G4-F8 V2 Iso Box-F 200 G4-F8-Carbon V2		Iso Box-F 200 G4-H13 V2 Iso Box-F 200 G4-H13-Carbon V2	
	min	max	min	max	min	max
Speed						
Voltage [V]	1 ~ 230		1 ~ 230		1 ~ 230	
Frequency [Hz]	50		50		50	
Power [W]	106	123	103	121	97	119
Current [A]	0.47	0.59	0.45	0.57	0.43	0.55
Maximum air flow [m³/h (l/s)]	390 (108)	630 (175)	380 (106)	590 (164)	350 (97)	525 (146)
RPM [min⁻¹]	700	1200	700	1200	700	1200
Sound pressure at 3 m [dBA]	22	38	22	38	22	38
Transported air temperature [°C]	-25..+40		-25..+40		-25..+40	
IP rating	IPX4		IPX4		IPX4	
PM2.5 Ratio [%]	37	28	98	97	99	98
SEC class	C		D		D	
ErP	2018		2018		2018	

ISO BOX-F 200 V2

Sound power level, A-weighted	Total	Octave frequency bands [Hz]								LpA 3 m [dBA]	LpA 1 m [dBA]	
		63	125	250	500	1000	2000	4000	8000			
min	LWA to inlet [dBA]	55	44	45	47	48	47	48	46	44	35	45
	LWA to outlet [dBA]	58	46	45	54	51	49	47	44	38	37	47
	LWA to environment [dBA]	43	31	34	38	39	28	24	21	25	22	32
max	LWA to inlet [dBA]	67	55	56	58	60	58	59	57	55	46	56
	LWA to outlet [dBA]	71	58	56	68	63	61	59	55	47	50	60
	LWA to environment [dBA]	58	44	48	54	55	40	34	30	36	38	48

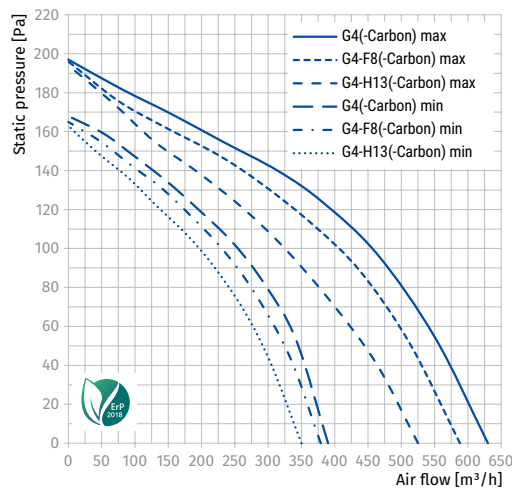

SOUND-INSULATED FANS