

KOMFORT ULTRA S 250

Compact heat recovery air handling units

Features

- Air handling units for efficient supply and exhaust ventilation in flats, houses, cottages and other buildings.
- Heat and humidity recovery reduces ventilation heat losses in the cold season and the load on the air conditioners in the hot season.
- Control of air exchange for creating comfortable indoor microclimate.
- Compatible with round Ø 125 mm air ducts.



Air flow:
up to 250 m³/h
69 l/s



Heat recovery efficiency:
up to 78 %



Design

- The casing of **KOMFORT Ultra S 250-H(E) S12** is made of double-skinned aluzinc panels, internally filled with 20 mm mineral wool layer for heat- and sound-insulation.
- The casing of **KOMFORT Ultra S 250-H(E) S12 white** is made of double-skinned white painted metal panels, internally filled with 20 mm mineral wool layer for heat and sound insulation.
- The spigots are located at the top of the unit and are rubber sealed for airtight connection to the air ducts.
- The hinged panel of the casing ensures easy access to the unit internals for service works including cleaning, filter replacement, etc.

Fans

- Asynchronous external rotor motors and centrifugal impellers with backward curved blades are used for air supply and exhaust.
- Integrated motor overheating protection with automatic restart.
- Dynamically balanced impellers.
- Equipped with ball bearings for longer service life.
- Reliable and quiet operation.

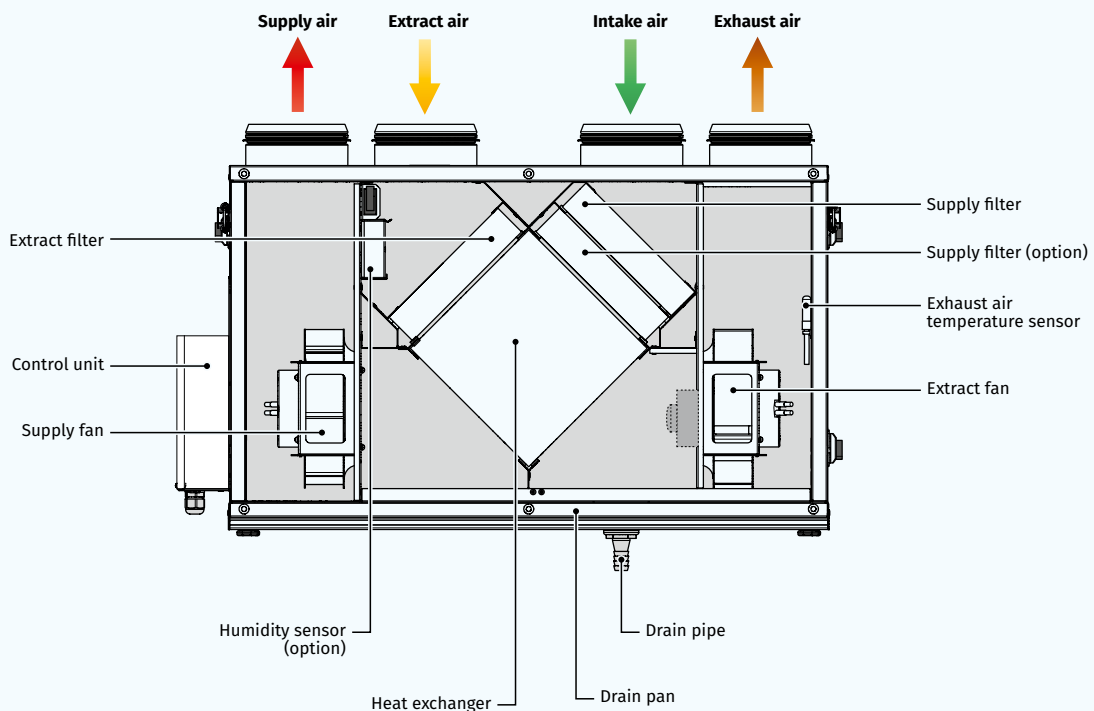

Heat recovery

The **KOMFORT Ultra S 250-H S12 (white)** unit is equipped with a plate cross-flow polystyrene heat exchanger for heat recovery. The unit condensate is collected and drained to the drain pan under the heat exchanger.

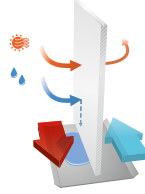

The **KOMFORT Ultra S 250-E S12 (white)** unit is equipped with an enthalpy plate cross-flow heat exchanger for energy (heat and humidity) recovery. Due to humidity recovery condensate is not generated in the enthalpy heat exchanger.



- The air flows are completely separated in the heat exchanger. Thus smells and contaminants are not transferred from the extract air to the supply air.
- Heat recovery is based on heat and/or humidity transfer through the heat exchanger plates. In the cold season supply air is heated in the heat exchanger by transferring the heat energy of warm and humid extract air to the cold fresh air. Heat recovery minimizes ventilation heat losses and heating costs respectively.
- In the warm season the heat exchanger performs reverse and intake air is cooled in the heat exchanger by the cool extract air. That reduces operation load on air conditioners and saves electricity.
- When the indoor and outdoor temperature difference is insignificant, heat recovery is not reasonable. In this case the heat exchanger can be temporary replaced with a summer block for the warm season (available as a specially ordered accessory).

FREEZE PROTECTION

- The integrated automatic freeze protection is used to prevent freezing of the heat exchanger in the cold season. The supply fan turns off according to the temperature sensor to get the heat exchanger warmed up with extract air. After that the supply fan turns on and the unit continues to run in the standard mode.

Designation key

Series	Unit type	Spigot modification	Rated air flow [m³/h]	Heat exchanger type	Control	Casing
KOMFORT	Ultra: compact unit	S: vertical spigot orientation	250	— H: heat recovery E: energy recovery	S12: speed controller SGS E1	—: aluzinc white: white-painted steel

Overall dimensions [mm]

Model	D	B	H	H1	L	L1
KOMFORT Ultra S 250-H(E) S12 (white)	125	300	443	490	713	43

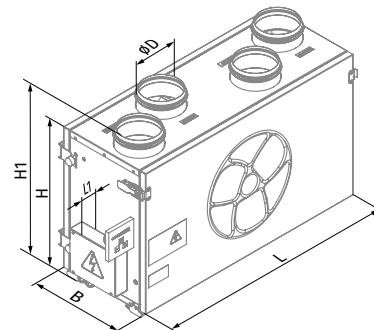

Air filtration

- The built-in G4 supply filter and G4 extract filter provide air filtration.
- The F8 supply filter (specially ordered accessory) may be used for efficient supply air filtration.

Control and automation

- Smooth motor speed control from 0 up to 100 % by means of the thyristor speed controller SGS E1 (included in the delivery).

Mounting





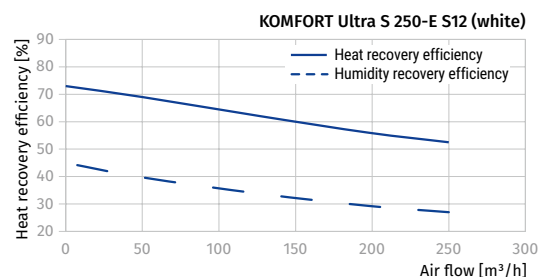
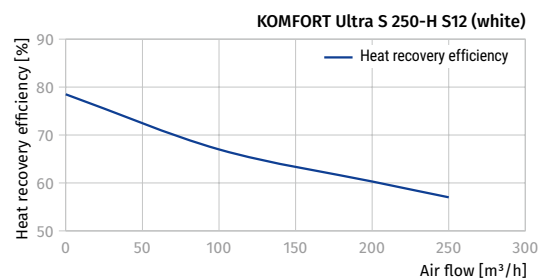
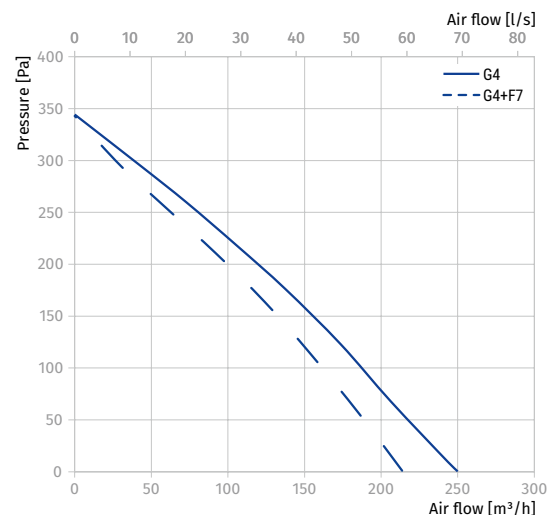

- The units can be fixed to the wall or mounted on the floor using the mounting brackets. The **KOMFORT Ultra S 250-E S12 (white)** unit is also suitable for ceiling mounting.
- While mounting provide free access to the service panel for filter replacement and servicing.
- The **KOMFORT Ultra S 250-H S12 (white)** unit mounting position must provide condensate collection and drainage.
- Due to universal casing design both left and right mounting is possible. It requires swapping the service and the back panel.

Technical data

Parameters	KOMFORT Ultra S 250-H S12 KOMFORT Ultra S 250-H S12 white	KOMFORT Ultra S 250-E S12 KOMFORT Ultra S 250-E S12 white
Voltage [V / 50 (60) Hz]	1 ~ 230	1 ~ 230
Power [W]	148	148
Current [A]	0.78	0.78
Maximum air flow [m ³ /h (l/s)]	250 (69)	250 (69)
RPM [min ⁻¹]	2700	2700
Sound pressure level at 3 m [dBA]	28-47	28-47
Transported air temperature [°C]	-25...+40	-25...+40
Insulation	20 mm mineral wool	20 mm mineral wool
Extract filter	G4	G4
Supply filter	G4 (option: F8 PM2.5 > 81 %)	G4 (option: F8 PM2.5 > 81 %)
Connected air duct diameter [mm]	125	125
Heat recovery efficiency [%]	55-78	52-73
Humidity recovery efficiency [%]	-	27-45
Heat exchanger type	cross-flow	cross-flow
Heat exchanger material	polysterene	enthalpy
SEC class	E	E
ErP	2016	2016



Accessories

		KOMFORT Ultra S 250-H S12 KOMFORT Ultra S 250-H S12 white	KOMFORT Ultra S 250-E S12 KOMFORT Ultra S 250-E S12 white
G4 panel filter		FP 240x184x40 G4	FP 240x184x40 G4
F8 panel filter		FP 240x184x40 F8	FP 240x184x40 F8
Silencer		SD 125	SD 125
Silencer		SDF 125	SDF 125
Backdraft air damper		VRV 125	VRV 125
Air damper		VK 125	VK 125
Summer block		SB C4 200/240	SB C4 200/240