

MRDL / MRIDL

Mounting frames

Use

- For facilitation of mounting and installation of **Tower-H, Tower-V, Tower-H EC, Tower-V EC, Tower-A, Tower-AL** roof fans on the flat roof.
- Prevents water ingress inside a ventilation shaft or air duct.



Design

- Mounting frames in standard (**MRDL** model) or sound-insulated modifications (**MRIDL** model).
- The casing is made of galvanized steel.
- MRIDL** models are equipped with 20 mm heat- and sound-insulated mineral wool layer.
- Specially designed flanges on the frame bottom enable easy and reliable mounting on the roof.
- The casing has threaded openings for fastening of the fan with bolts.
- Size 630-1100 is equipped with a detachable bolted panel for mounting facilitation.

Mounting

- Fixing on the roof with flanges in the bottom with subsequent extra insulation.
- The fan is attached to the roof frame with bolts.

Overall dimensions [mm]

Type	Standard size of compatible fans	B	B1	H	L	L1	Weight [kg]
MRDL 220-225	190, 220, 225	720	254	300.5	301	245	10.4
MRDL 250-315	250, 280, 310	810	352	300.5	401	330	12.0
MRDL 355-400	355, 400	980	506	300.5	561	450	16.4
MRDL 450-500	450, 500	997	576	300.5	631	535	16.9
MRDL 560	560	1180	770	300.5	817	750	26.7
MRDL 630	630	1212	852	600.0	912	750	65.9
MRDL 710, 800	710, 800	1262	902	600.0	962	840	68.5
MRDL 900	900	1512	1152	650.0	1212	1050	85.7
MRDL 1000, 1100	1000, 1100	1712	1352	730.0	1412	1240	103.7

Type	Standard size of compatible fans	B	B1	H	L	L1	Weight [kg]
MRIDL 220-225	190, 220, 225	720	254	300.5	301	245	13.8
MRIDL 250-315	250, 280, 310	810	352	300.5	401	330	16.9
MRIDL 355-400	355, 400	980	506	300.5	561	450	20.3
MRIDL 450-500	450, 500	997	576	300.5	631	535	21.2
MRIDL 560	560	1180	770	300.5	817	750	35.7
MRIDL 630	630	1212	850	600.0	912	750	85.5
MRIDL 710, 800	710, 800	1262	900	600.0	962	840	89.0
MRIDL 900	900	1512	1150	650.0	1212	1050	113.0
MRIDL 1000, 1100	1000, 1100	1712	1350	730.0	1412	1240	140.6

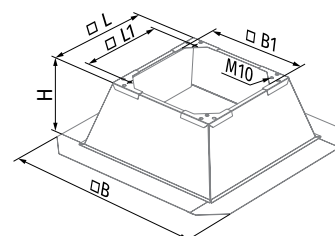

MRDL 220-225 – MRDL 560
MRIDL 220-225 – MRIDL 560

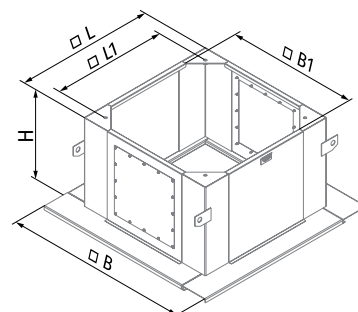

MRDL 630 – MRDL 1000-1100

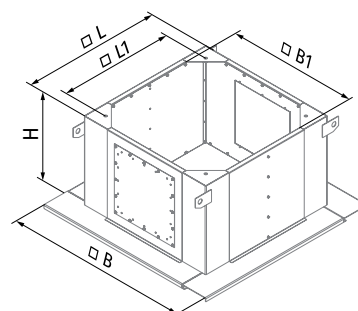

MRIDL 630 – MRIDL 1000-1100