



Centrifugal roof fans

Tower-H

Air capacity – up to 4700 m³/h



Use

- Exhaust ventilation systems installed in various premises.
- Roof mounting.
- For any types of roofs or vertical ventilation shafts.

Design

- Steel casing with a special polymer atmospheric resistant coating.
- Horizontal air exhaust.
- The fan is equipped with a terminal block for connection to power mains.
- The fan is rated for continuous operation.
- Impeller with a protecting insect screen.
- The upper cover is equipped with two eye bolts for easy fan lifting on the roof with hoisting mechanism.
- A connecting plate with an intake opening is designed to facilitate mounting to the roof surface.

Motor

- Two-, four- or six-pole asynchronous motor with external rotor and centrifugal impeller with backward curved blades.
- Single-phase (E) or three-phase (D) motor modifications.
- Dynamically balanced turbine.
- Equipped with ball bearings for longer service life.

- Overheating protection by built-in thermal switches with leaded outside terminals for connection to external protecting controls.
- The thermal switch terminal leads are designed for connection to respective circuit of the overload relay or respective terminals of the autotransformer or thyristor speed controller.

Speed control

- Smooth or step speed control with a thyristor or transformer speed controller (available upon order).

Mounting

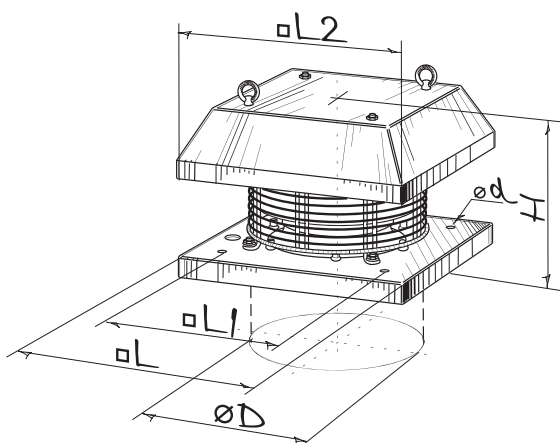

- Roof mounting directly above a ventilation shaft or air duct.
- The fan is connected to the air duct with the intake flange that is fixed to the fan base.
- The fan base has holes for fixing bolts that attach the fan to the stable level surface or a roof frame.
- Roof frame and intake flange available on separate order.
- Power is supplied through an external terminal box.

Overall dimensions



Type	Dimensions [mm]						Weight [kg]
	øD	ød	H	L	L1	L2	
Tower-H 220 2E	213	10	228	338	245	338	6.9
Tower-H 225 2E	213	10	228	338	245	338	7.1
Tower-H 250 2E	285	10	265	425	330	365	10.1
Tower-H 280 2E	285	10	265	425	330	365	10.2
Tower-H 310 4E	285	10	300	438	330	400	10.2
Tower-H 310 4D	285	10	300	438	330	400	10.2
Tower-H 355 4E	438	12	348	598	450	550	15.6
Tower-H 355 4D	438	12	325	598	450	550	15.6
Tower-H 400 4E	438	12	348	598	450	550	21.0
Tower-H 450 4E	438	12	400	668	535	640	22.7
Tower-H 400 4D	438	12	323	598	450	550	22.0
Tower-H 450 4D	438	12	400	668	535	640	22.7
Tower-H 500 6E	438	12	465	668	535	640	26.6

Specifications

Parameters	Tower-H 220 2E 	Tower-H 225 2E 	Tower-H 250 2E	Tower-H 280 2E
Voltage [V / 50 Hz]	230	230	230	230
Power [W]	85	135	155	225
Current [A]	0.38	0.6	0.7	1.0
Maximum air capacity [m ³ /h]	700	900	1300	1780
RPM [min ⁻¹]	2700	2650	2600	2700
Sound pressure level at 3 m distance [dBA]	49	49	65	66
Max. operating temperature [°C]	55	55	50	50
SEC class	B		-	-
Ingress protection rating	IPX4	IPX4	IPX4	IPX4

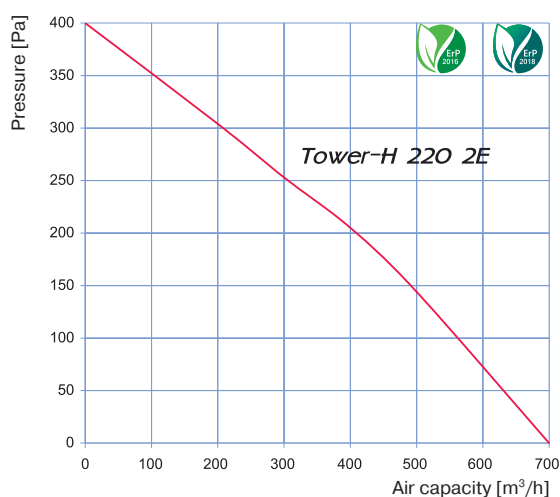

Sound-power level	Octave-frequency band [Hz]								
	Gen	63	125	250	500	1000	2000	4000	8000
L _{WA} to inlet, [dBA]	69	42	60	65	68	65	61	59	50
L _{WA} to environment, [dBA]	73	42	60	65	67	67	65	57	50

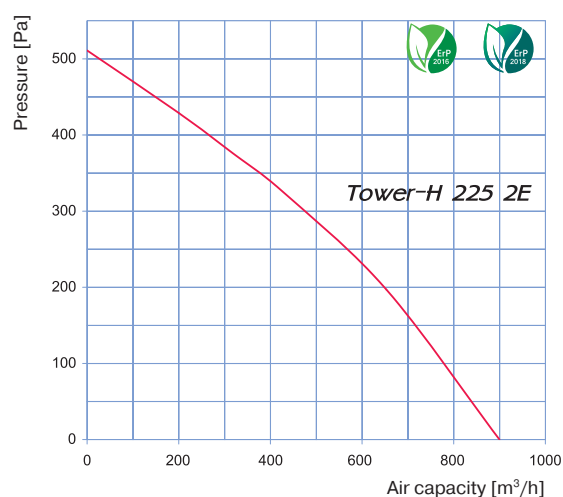

Sound-power level	Octave-frequency band [Hz]								
	Gen	63	125	250	500	1000	2000	4000	8000
L _{WA} to inlet, [dBA]	72	41	59	66	68	66	61	57	49
L _{WA} to environment, [dBA]	72	42	60	67	69	66	63	58	51

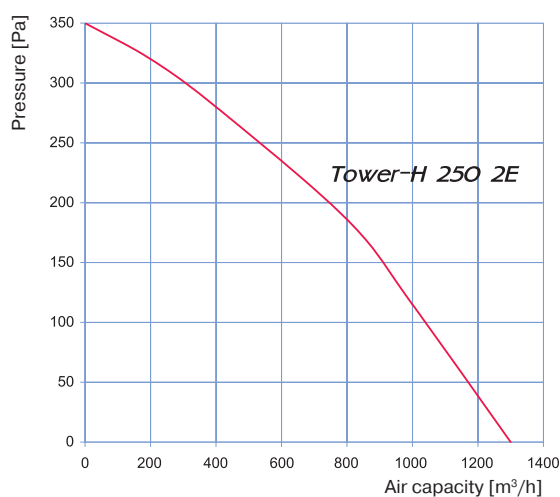

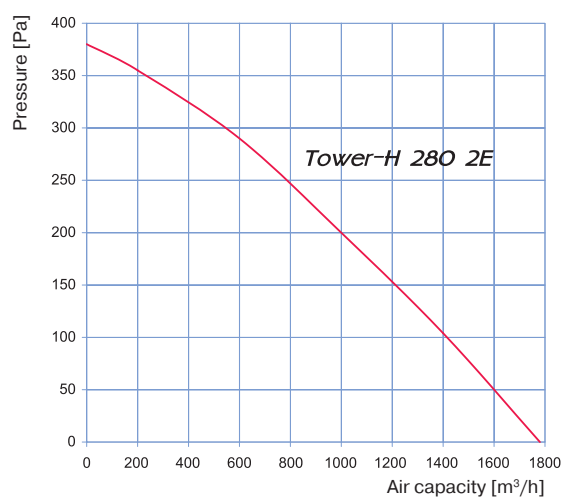

Sound-power level	Octave-frequency band [Hz]								
	Gen	63	125	250	500	1000	2000	4000	8000
L _{WA} to inlet, [dBA]	69	40	62	65	66	66	64	57	49
L _{WA} to environment, [dBA]	71	44	59	65	68	66	62	60	53



Sound-power level	Octave-frequency band [Hz]								
	Gen	63	125	250	500	1000	2000	4000	8000
L _{WA} to inlet, [dBA]	72	42	58	62	64	65	63	56	49
L _{WA} to environment, [dBA]	72	45	61	63	66	66	61	60	53

Specifications

Parameters	Tower-H 310 4E 	Tower-H 310 4D 	Tower-H 355 4E 	Tower-H 355 4D 
Voltage [V / 50 Hz]	230	400	230	400
Power [W]	120	110	245	170
Current [A]	0.54	0.32	1.12	0.52
Maximum air capacity [m ³ /h]	1820	1950	2800	2350
RPM [min ⁻¹]	1370	1400	1420	1400
Sound pressure level at 3 m distance [dBA]	45	53	46	53
Max. operating temperature [°C]	85	65	50	70
Ingress protection rating	IPX4	IPX4	IPX4	IPX4

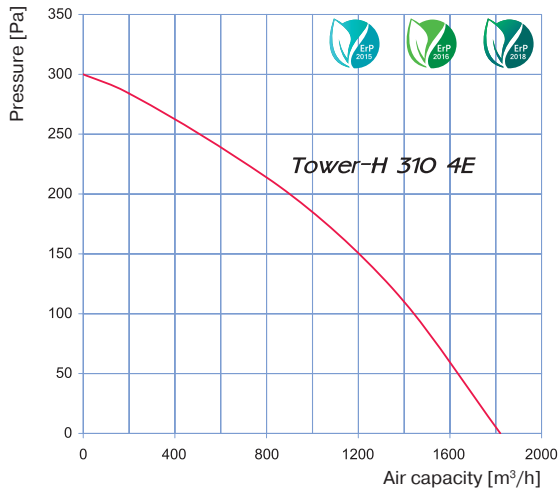

Sound-power level	Octave-frequency band [Hz]								
	Gen	63	125	250	500	1000	2000	4000	8000
L _{WA} to inlet, [dBA]	57	44	45	50	53	52	51	43	36
L _{WA} to environment, [dBA]	60	47	50	53	56	57	51	45	39

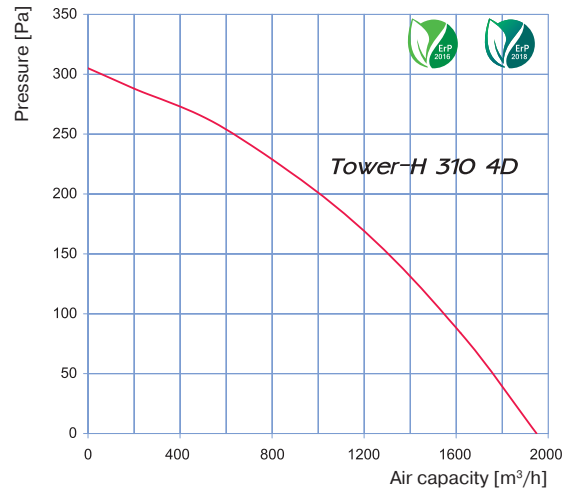

Sound-power level	Octave-frequency band [Hz]								
	Gen	63	125	250	500	1000	2000	4000	8000
L _{WA} to inlet, [dBA]	58	45	46	51	55	53	49	45	37
L _{WA} to environment, [dBA]	60	48	51	52	54	56	49	44	38

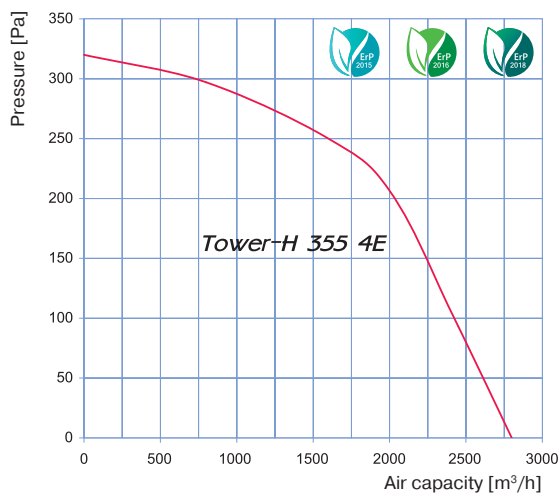



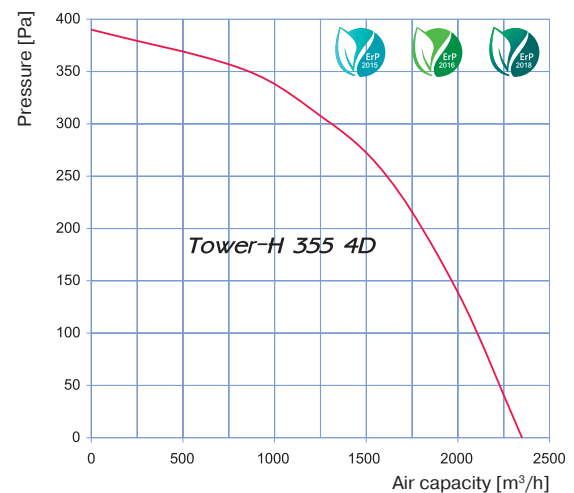

Sound-power level	Octave-frequency band [Hz]								
	Gen	63	125	250	500	1000	2000	4000	8000
L _{WA} to inlet, [dBA]	69	53	58	61	62	63	59	54	45
L _{WA} to environment, [dBA]	72	57	60	63	65	64	61	55	49



Sound-power level	Octave-frequency band [Hz]								
	Gen	63	125	250	500	1000	2000	4000	8000
L _{WA} to inlet, [dBA]	67	56	57	63	65	64	59	54	47
L _{WA} to environment, [dBA]	72	56	60	62	66	62	63	55	49

Specifications

Parameters	Tower-H 400 4E 	Tower-H 400 4D 	Tower-H 450 4E 	Tower-H 450 4D 	Tower-H 500 6E 
Voltage [V / 50 Hz]	230	400 Y	230	400 Y	230
Power [W]	480	385	640	470	385
Current [A]	2.4	0.7	3.1	0.82	1.82
Maximum air capacity [m ³ /h]	3400	3800	3850	4300	4700
RPM [min ⁻¹]	1400	1430	1350	1430	880
Sound pressure level at 3 m distance [dBA]	52	52	53	53	47
Max. operating temperature [°C]	80	60	50	50	50
Ingress protection rating	IPX4	IPX4	IPX4	IPX4	IPX4

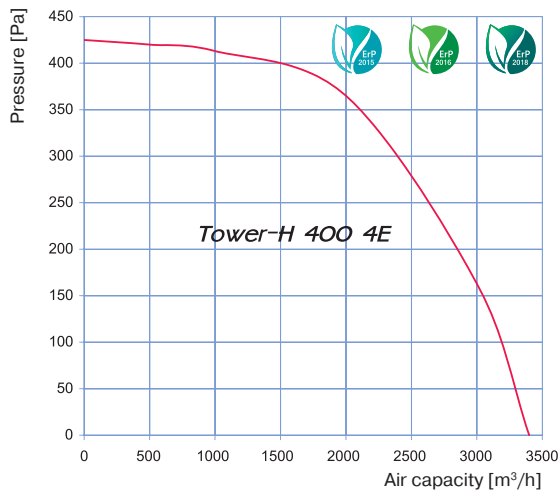

Sound-power level	Octave-frequency band [Hz]								
	Gen	63	125	250	500	1000	2000	4000	8000
L _{WA} to inlet, [dBA]	72	58	62	67	69	68	63	58	52
L _{WA} to environment, [dBA]	76	61	63	68	70	68	65	60	53

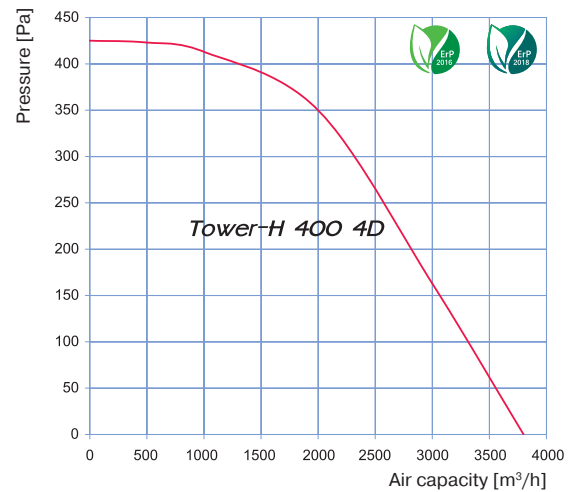

Sound-power level	Octave-frequency band [Hz]								
	Gen	63	125	250	500	1000	2000	4000	8000
L _{WA} to inlet, [dBA]	72	59	63	65	67	68	63	58	51
L _{WA} to environment, [dBA]	74	59	62	65	69	69	66	59	53

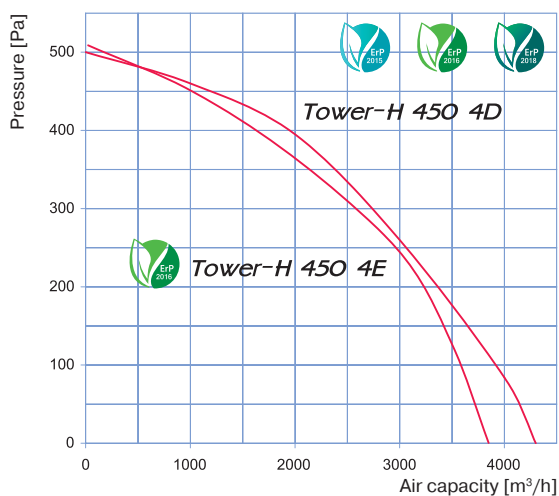

Sound-power level	Octave-frequency band [Hz]								
	Gen	63	125	250	500	1000	2000	4000	8000
Tower-V 450 4E									
L _{WA} to inlet, [dBA]	63	51	54	58	59	61	56	50	41
L _{WA} to environment, [dBA]	68	51	53	60	61	61	58	52	43
Tower-V 450 4D									
L _{WA} to inlet, [dBA]	64	49	55	59	60	60	56	48	42
L _{WA} to environment, [dBA]	66	51	56	58	61	61	56	52	46

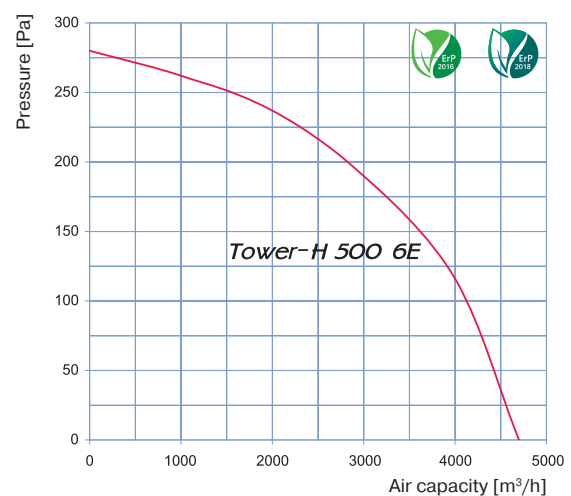

Sound-power level	Octave-frequency band [Hz]								
	Gen	63	125	250	500	1000	2000	4000	8000
L _{WA} to inlet, [dBA]	67	54	55	59	61	64	59	55	46
L _{WA} to environment, [dBA]	70	56	56	62	64	63	60	56	45