

# VENTO INHOME / VENTO INHOME MINI

## HEAT RECOVERY SINGLE-ROOM UNITS

### Features

- o inHome is a brand new dMVHR solutions for newbuild and retrofit single-room applications, offer efficient and cost-effective ventilation.
- o New and stylish design of indoor unit will fit into any interior.
- o Built-in light sensor controls the brightness of the control panel LEDs and activates night mode automatically.
- o Built-in humidity sensor allows unit to automatically select the mode, control the humidity level and prevents mold growth.
- o Silent operation, making it perfect for living spaces.
- o High efficiency (up to 95 %) heat recovery to reduce energy costs and helps you save on heating and air conditioning.



**Air flow:**  
up to 50 m<sup>3</sup>/h  
14 l/s



**Heat recovery efficiency:**  
up to 95 %



**Power:** from 1.0 W  
**SFP:** from 0.62 W/l/s



**Noise level:**  
from 10 dBA



### Design

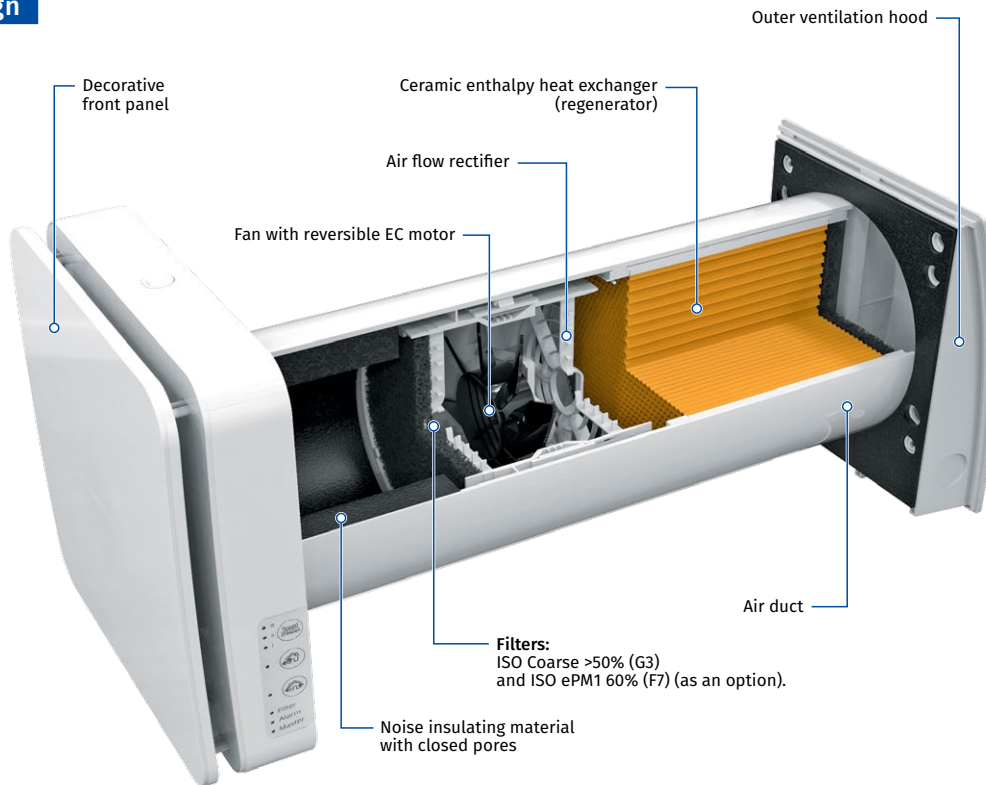

- o Low power consumption, making inHome suitable for continuous operation without significantly impacting energy bills.
- o Remote management through a remote control.
- o Easy to mount through external walls without the need for complex ducting.
- o Operation within a network guarantees balanced ventilation.

- o Higher degree of supply air purification can be achieved with an ISO ePM1 60% (F7) filter (optional).
- o Possibility to connect external sensors.
- o Equipped with an automatic shutter to prevent undesired external entry when turned off (optional).

### Designation key

Model	Control	Air duct	Ventilation hood type	Front panel
Vento inHome / Vento inHome mini	<p>_: control of the unit operation mode is performed by means of sensor control panel located on the unit casing or a remote controller</p> <p>W: control of the unit operation mode is performed by means of sensor control panel located on the unit casing, remote controller or mobile application via Wi-Fi</p>	<p>_: integrated automatic air shutters</p> <p>M: without integrated automatic air shutters</p>	<p>_: white plastic hood AH-11 white 160 (for standard walls)</p> <p>S: metal hood (for thin walls)</p>	<p>_: white</p> <p>BLK: black</p>

# VENTO INHOME / VENTO INHOME MINI

## HEAT RECOVERY SINGLE-ROOM UNITS

### Control

- The ventilators can be connected into one network for centralized control. The signals from the control panel, remote control, as well as from the humidity sensor, are received only by the master (main) ventilator.

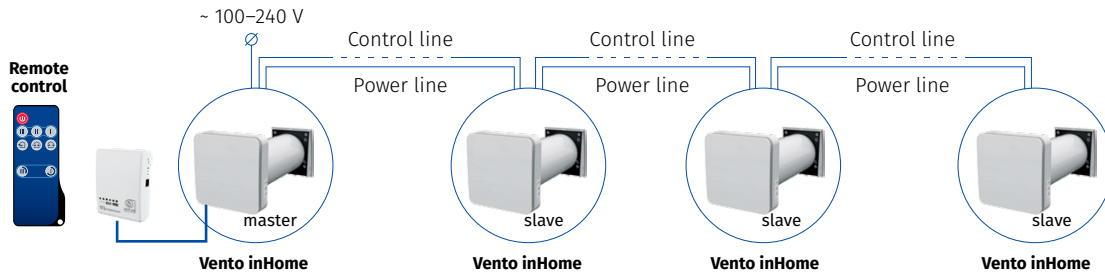

- Control of the unit operation mode is also performed by means of the sensor control panel located on the unit casing or the remote control.

- Vento inHome** is equipped with a humidity sensor for indoor humidity control. If humidity increases above a set point, the unit boosts to the speed III.

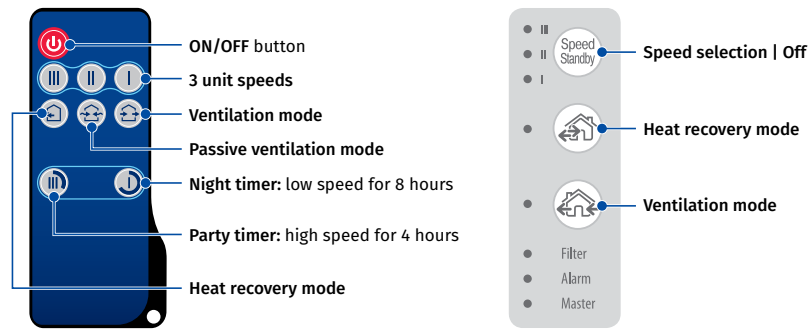

### Energy recovery

#### UNIT OPERATING LOGIC IN WINTER PERIOD

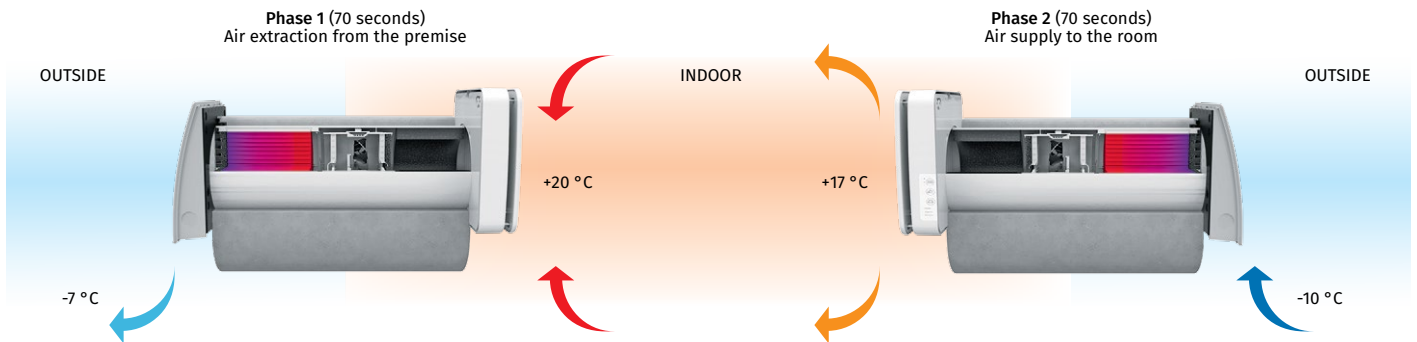

- Warm stale air is extracted from the premise, flows through the ceramic heat exchanger and transfers its heat and moisture to it.
- As the ceramic heat exchanger gets warmed up, the unit switches to the supply mode.

- Clean cold intake air flows through the heat exchanger and absorbs accumulated heat and humidity.
- When the heat exchanger is cooled down, the unit switches to the extract air mode.

# VENTO INHOME / VENTO INHOME MINI

## HEAT RECOVERY SINGLE-ROOM UNITS

### Mounting

- The unit is designed for through-the-wall installation inside a prepared hole in an outer wall of the building.
- The best ventilation solution is pairwise installation of reverse phase synchronized units. Some units ensure supply of fresh air to the room and the other units extract air from the premise. This way the most efficient balanced ventilation is arranged.
- In case of brand new construction, units are mounted in two stages:
  - Pre-installation of an air duct and an outer ventilation hood at the stage of indoor finishing and outer decorative wall finishing.
  - Completion of the installation before commissioning of a house. It includes installation of the indoor unit with controller and shutters the cartridge, the heat exchanger, the fan and the filters. **OUTSIDE**

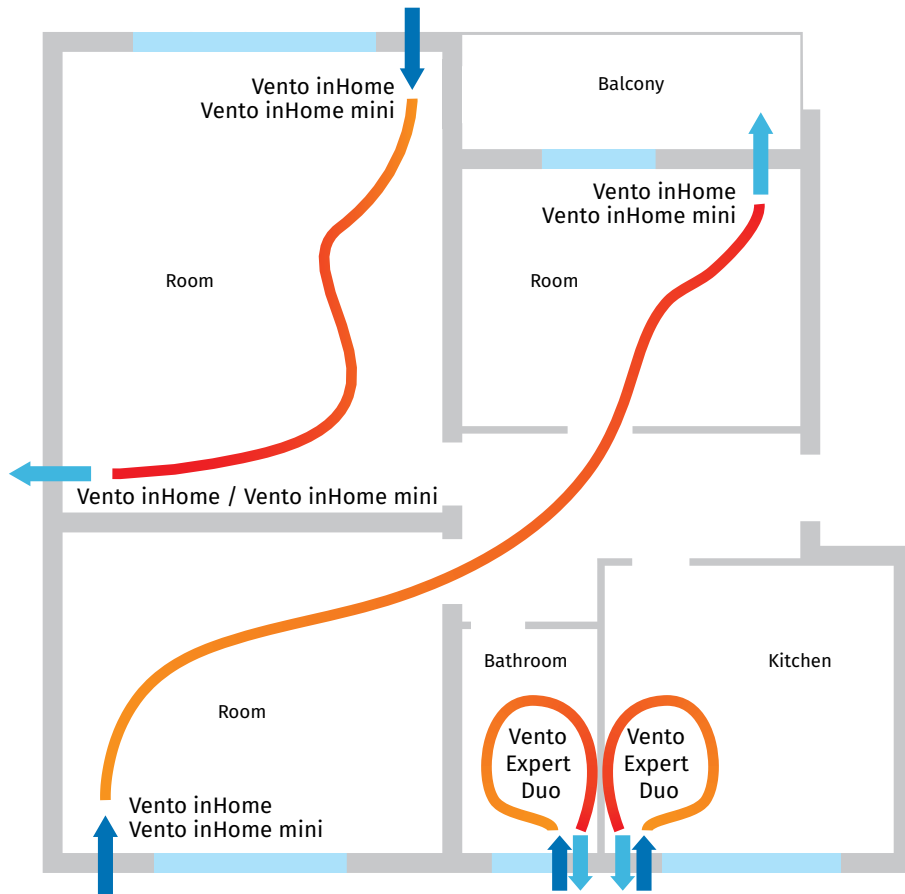

Angular mounting into a wall with standard thickness using  
**KIT BlauPlast white 160 / KIT BlauPlast chrome 160**

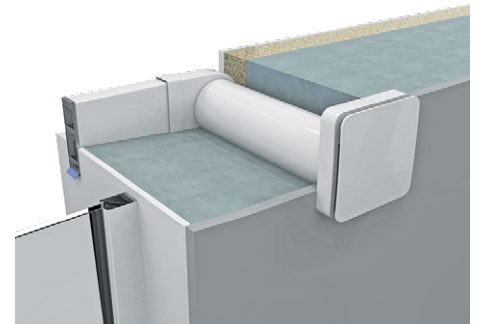

Unit installation example with the hood for thin walls  
**AH-S grey 160 / AH-S chrome 160**

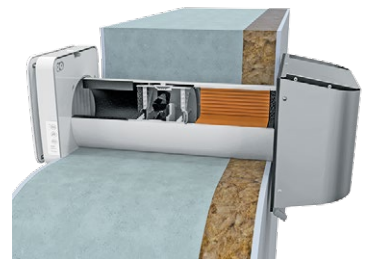

# VENTO INHOME / VENTO INHOME MINI

## HEAT RECOVERY SINGLE-ROOM UNITS

### Technical data

Parameters	Vento inHome			Vento inHome mini		
	I	II	III	I	II	III
Speed						
Voltage [V / 50 (60) Hz]	100-240			100-240		
Power [W]	1.10	2.00	3.40	1.0	1.6	3.0
Current [A]	0.03	0.04	0.05	0.02	0.03	0.04
Air flow in ventilation mode [m³/h (l/s)]	15 (4)	35 (10)	50 (14)	8 (2)	16 (4)	25 (7)
Air flow in energy recovery mode [m³/h (l/s)]	8 (2)	15 (4)	25 (7)	4 (1)	8 (2)	13 (3)
SFP [W/l/s]	0.53	0.48	0.49	0.90	0.72	0.86
Filter	ISO Coarse >50% (G3) (ISO Coarse >60% (G4), ISO ePM1 60% (F7) optional)					
Transported air temperature [°C]	-20...+40			-15...+40		
Sound pressure level at 1 m distance [dBA]	20	30	36	20	26	33
Sound pressure level at 3 m distance [dBA]	11	21	27	10	16	23
Outdoor sound pressure attenuation in accordance with DIN EN 20140 [dBA]	40 / 44					
Heat recovery efficiency	up to 95 %			up to 81%		
Protection class	IP24					

### Overall dimensions [mm]

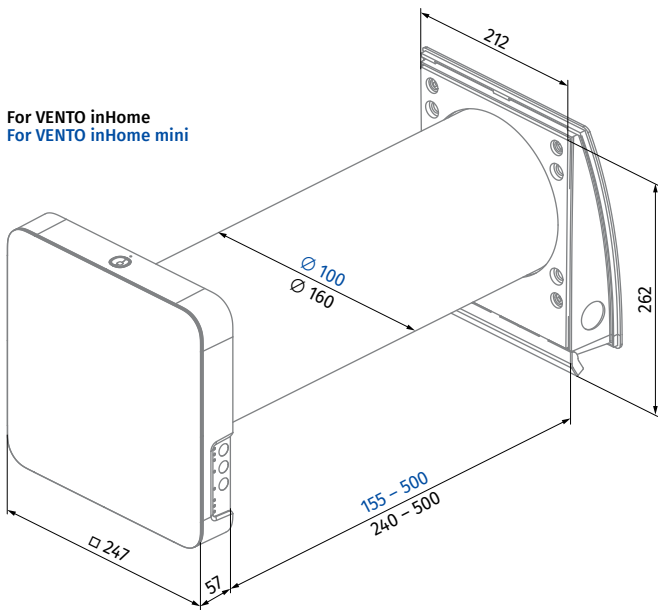

BLAUBERG Vento inHome

A+ A+ 41 dBA 50 m³/h

ENERGIA - ЕНЕРГИЯ - ΕΝΕΡΓΕΙΑ - ENERGIA - ENERGY - ENERGIE - ENERGI 2023 1254/2014

BLAUBERG Vento inHome mini













A+ A A B C D E F G 37 dBA 25 m³/h

ENERGIA - ЕНЕРГИЯ - ΕΝΕΡΓΕΙΑ - ENERGIA - ENERGY - ENERGIE - ENERGI 2023 1254/2014

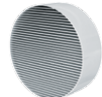
# VENTO INHOME / VENTO INHOME MINI

## HEAT RECOVERY SINGLE-ROOM UNITS

### Accessories

Vento inHome	Vento inHome mini		Description
Pre-installation Kit Vento inHome	Pre-installation Kit Vento inHome mini		Pre-installation kit for mounting into walls with standard thickness. Includes: • Air duct • AH-11 white 160 outer ventilation hood • Polystyrene foam plug • Polystyrene foam wedges
Pre-installation Kit Vento inHome S	Pre-installation Kit Vento inHome mini S		Pre-installation kit for mounting into thin walls. Includes: • Air duct • AH-S chrome 160 outer ventilation hood • Polystyrene foam plug • Polystyrene foam wedges
Completion Kit Vento inHome	Completion Kit Vento inHome mini		Final mounting kit. Includes: • Regenerator module • Fan module • G3 filters (2 pcs.) • Indoor unit with a controller and shutters • Remote control
FP2 Vento G3	FP3 Vento G3		G3 filters (2 pcs.)
FP2 Vento G4			Coarse filter. Includes: • Plastic filter holder (1 pc.) • G4 filter (1 pc.)
FPC 150x50 G4			G4 coarse filter
FP2 Vento F7			Filter set. Includes: • Plastic filter holder (1 pc.) • F7 fine filter (1 pc.). Filtration rate PM2.5 > 70 %
FPC 150x50 F7			F7 fine filter. Filtration rate PM2.5 > 70 %
AH-8 white 160	AH-8 white 100		White painted aluminium outer ventilation hood with frost protection for a cold climate
AH-8 chrome 160	AH-8 chrome 100		Brushed stainless steel outer ventilation hood with frost protection for a cold climate
AH-10 *colour* 160	AH-10 *colour* 100		Plastic outer ventilation hood. Available in colours: 
AH-10 chrome 160	AH-10 chrome 100		Plastic outer ventilation hood with a plate with brushed stainless steel effect finish

# VENTO INHOME / VENTO INHOME MINI

## HEAT RECOVERY SINGLE-ROOM UNITS

Vento inHome	Vento inHome mini		Description
AH-11 *colour* 160	AH-11 *colour* 100		Plastic outer ventilation hood. Available in colours:  white  black  anthracite grey  grey  terracotta  vintage
AH-S white 160	AH-S white 100		Stainless steel ventilation hood, painted white
AH-S chrome 160	AH-S chrome 100		Brushed stainless steel ventilation hood
PP 160/0.5	-		Outer ventilation hood for mounting from inside
KIT BlauPlast white 160	KIT BlauPlast white 100		Kit for angular mounting with white colour grille (for walls with standard thickness)
KIT BlauPlast chrome 160	KIT BlauPlast chrome 100		Kit for angular mounting with stainless steel outer grille (for walls with standard thickness)
R 160-500	R 100-500		500 mm air duct and polystyrene foam plug
R 160-700	R 100-700		700 mm air duct and polystyrene foam plug
FB Vento Expert A50	FB Vento Expert A50		Remote control
CD-1	CD-1		CO <sub>2</sub> sensor with LED CO <sub>2</sub> indication and a sensor button for operation mode selection
CD-2	CD-2		CO <sub>2</sub> sensor