

# VENTO INHOME W / VENTO INHOME MINI W

## HEAT RECOVERY SINGLE-ROOM UNITS

### Features

- o inHome is a brand new dMVHR solutions for newbuild and retrofit single-room applications, offer efficient and cost-effective ventilation.
- o New and stylish design of indoor unit will fit into any interior.
- o Built-in light sensor controls the brightness of the control panel LEDs and activates night mode automatically.
- o Built-in humidity sensor allows unit to automatically select the mode, control the humidity level and prevents mold growth.
- o Silent operation, making it perfect for living spaces.
- o High efficiency (up to 95 %) heat recovery to reduce energy costs and helps you save on heating and air conditioning.



**Air flow:**  
up to 50 m<sup>3</sup>/h  
14 l/s



**Heat recovery efficiency:**  
up to 95 %



**Power:** from 1.0 W  
**SFP:** from 0.62 W/l/s



**Noise level:**  
from 10 dBA



### Design

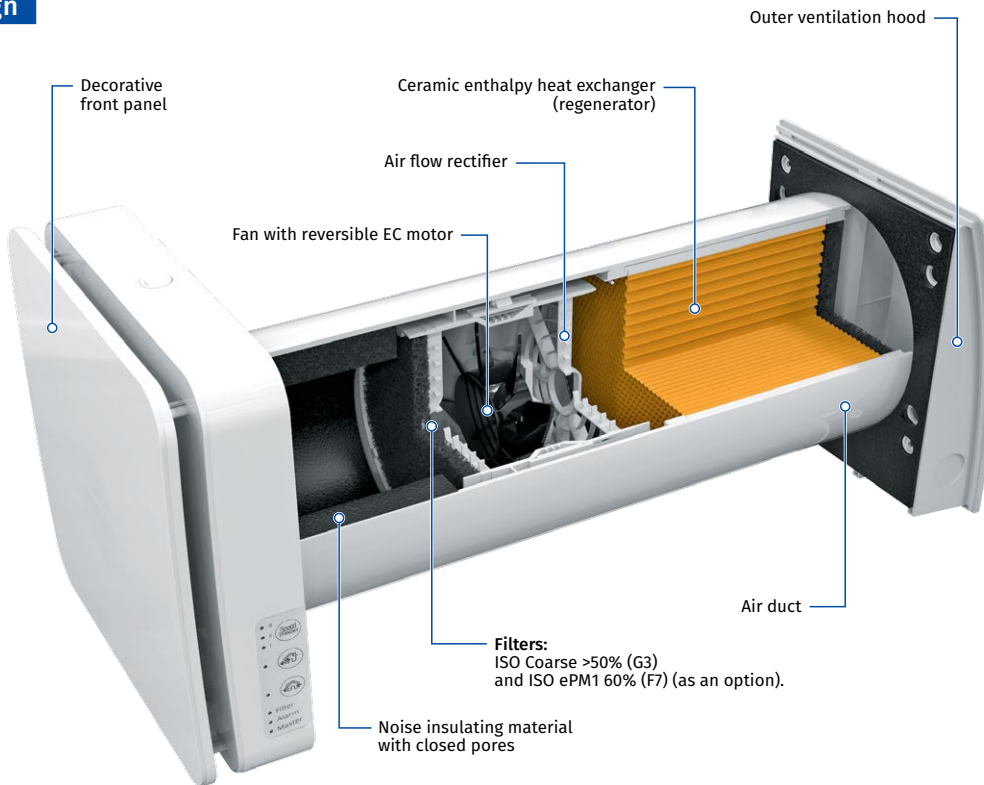

- o Low power consumption, making inHome suitable for continuous operation without significantly impacting energy bills.
- o No wires are needed to connect units into a one system.
- o Remote management through a remote control or smartphone.
- o Easy to mount through external walls without the need for complex ducting.

- o Operation within a network guarantees balanced ventilation.
- o Higher degree of supply air purification can be achieved with an ISO ePM1 60% (F7) filter (optional).
- o Possibility to connect external sensors.
- o Equipped with an automatic shutter to prevent undesired external entry when turned off (optional).

### Designation key

| Model                            | Control   | Air duct  | Ventilation hood type   | Front panel                       |
|----------------------------------|---|---|---|-----------------------------------|
| Vento inHome / Vento inHome mini | <p>_: control of the unit operation mode is performed by means of sensor control panel located on the unit casing or a remote controller</p> <p>W: control of the unit operation mode is performed by means of sensor control panel located on the unit casing, remote controller or mobile application via Wi-Fi</p> | <p>_: integrated automatic air shutters</p> <p>M: without integrated automatic air shutters</p> | <p>_: white plastic hood AH-11 white 160 (for standard walls)</p> <p>S: metal hood (for thin walls)</p> | <p>_: white</p> <p>BLK: black</p> |

# VENTO INHOME W / VENTO INHOME MINI W

## HEAT RECOVERY SINGLE-ROOM UNITS

### Control

- The ventilators can be connected into one network for centralized control. For Wi-Fi versions, units can be connected wirelessly. The signals from the control panel, remote control or smartphone (optional), as well as from the humidity sensor, are received only by the master (main) ventilator.

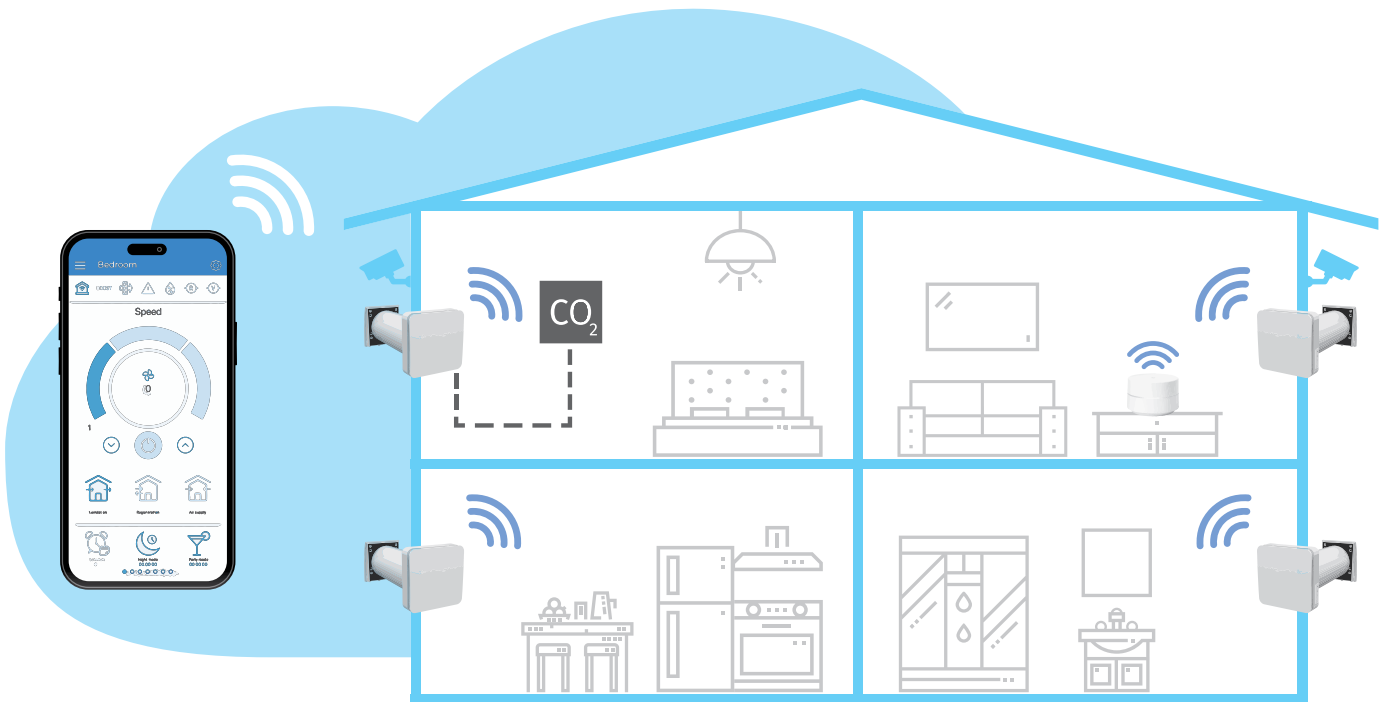
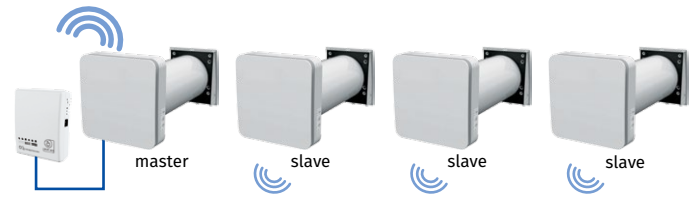

**Blauberg Home** app for Android or iOS devices is available at Google Play and App Store.



- Control of the unit operation mode is also performed by means of the sensor control panel located on the unit casing or the remote control.

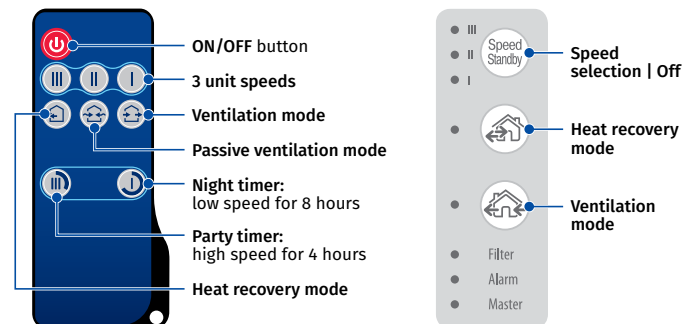

- Vento inHome** is equipped with a humidity sensor for indoor humidity control. If humidity increases above a set point, the unit boosts to the speed III.

# VENTO INHOME W / VENTO INHOME MINI W

## HEAT RECOVERY SINGLE-ROOM UNITS

### Energy recovery

#### UNIT OPERATING LOGIC IN WINTER PERIOD

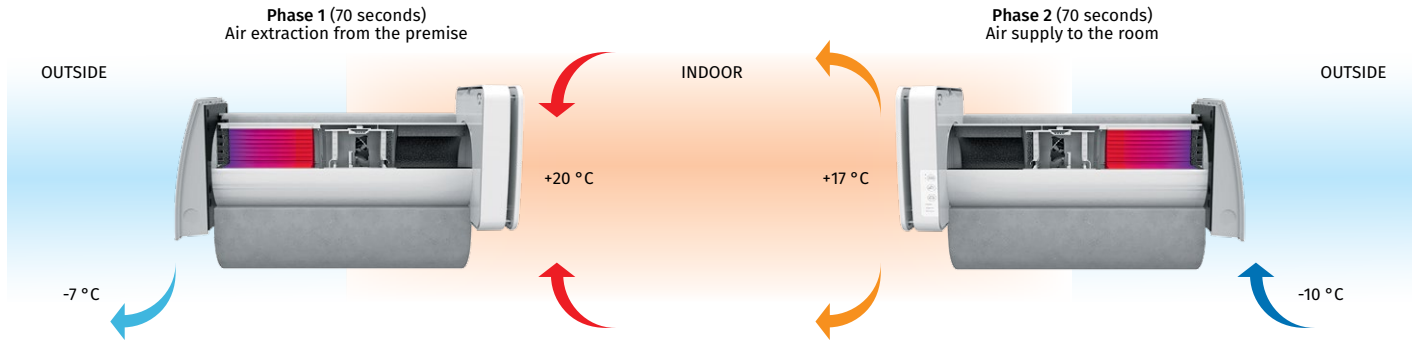

- Warm stale air is extracted from the premise, flows through the ceramic heat exchanger and transfers its heat and moisture to it.
- As the ceramic heat exchanger gets warmed up, the unit switches to the supply mode.
- Clean cold intake air flows through the heat exchanger and absorbs accumulated heat and humidity.
- When the heat exchanger is cooled down, the unit switches to the extract air mode.

### Mounting

- The unit is designed for through-the-wall installation inside a prepared hole in an outer wall of the building.
- The best ventilation solution is pairwise installation of reverse phase synchronized units. Some units ensure supply of fresh air to the room and the other units extract air from the premise. This way the most efficient balanced ventilation is arranged.
- In case of brand new construction, units are mounted in two stages:
  - Pre-installation of an air duct and an outer ventilation hood at the stage of indoor finishing and outer decorative wall finishing.
  - Completion of the installation before commissioning of a house. It includes installation of the indoor unit with controller and shutters the cartridge, the heat exchanger, the fan and the filters.

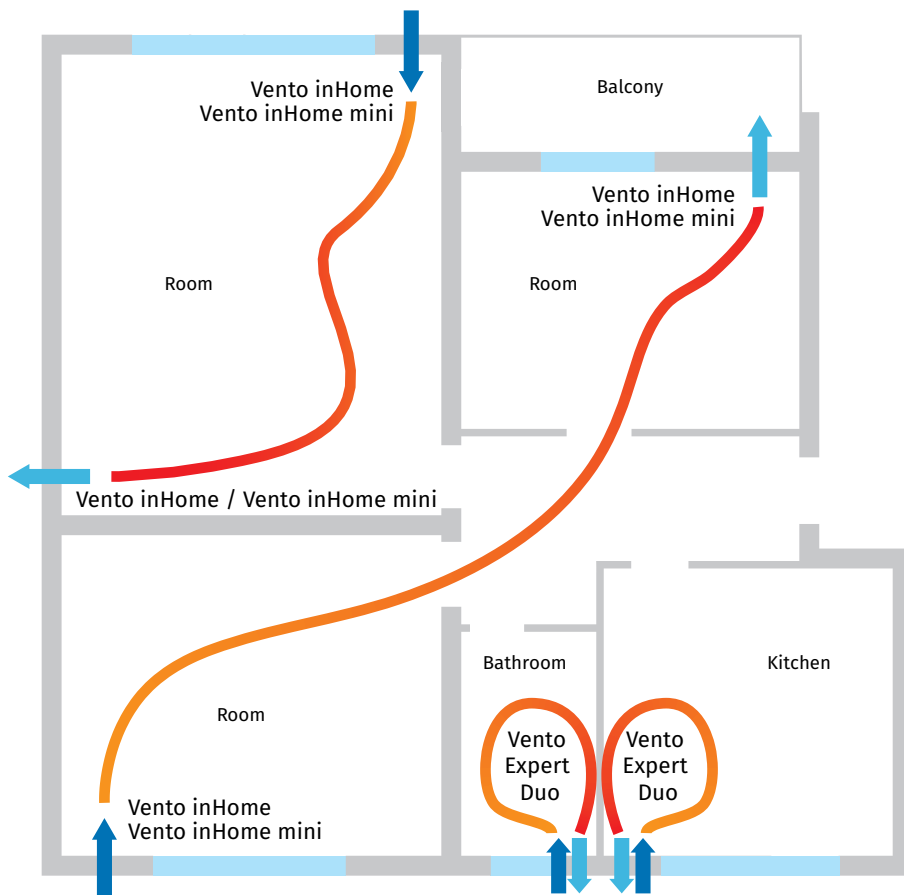

Angular mounting into a wall with standard thickness using  
**KIT BlauPlast white 160 / KIT BlauPlast chrome 160**

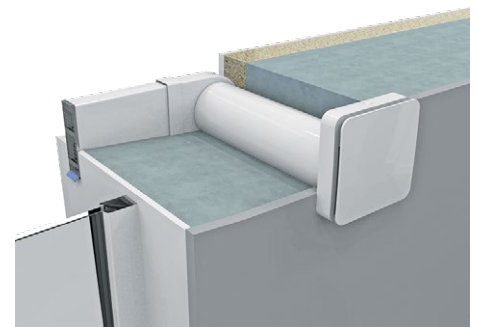

Unit installation example with the hood for thin walls  
**AH-S grey 160 / AH-S chrome 160**

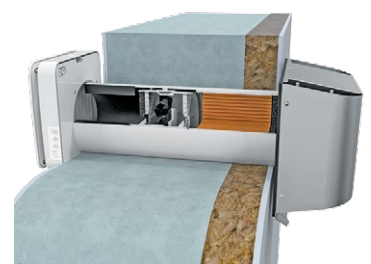

# VENTO INHOME W / VENTO INHOME MINI W

## HEAT RECOVERY SINGLE-ROOM UNITS

### Technical data

| Parameters   | Vento inHome W   |         |         | Vento inHome mini W |        |        |
|--|--|---------|---------|---------------------|--------|--------|
|  | I  | II      | III     | I                   | II     | III    |
| Speed  |  |         |         |                     |        |        |
| Voltage [V / 50 (60) Hz]   | 100-240  |         |         | 100-240             |        |        |
| Power [W]  | 1.1  | 2.0     | 3.4     | 1.0                 | 1.6    | 3.0    |
| Current [A]  | 0.03   | 0.04    | 0.05    | 0.02                | 0.03   | 0.04   |
| Air flow in ventilation mode [m³/h (l/s)]                                | 15 (4)   | 35 (10) | 50 (14) | 8 (2)               | 16 (4) | 25 (7) |
| Air flow in energy recovery mode [m³/h (l/s)]                            | 8 (2)  | 15 (4)  | 25 (7)  | 4 (1)               | 8 (2)  | 13 (3) |
| SFP [W/l/s]  | 0.53   | 0.48    | 0.49    | 0.90                | 0.72   | 0.86   |
| Filter   | ISO Coarse >50% (G3)<br>(ISO Coarse >60% (G4), ISO ePM1 60% (F7) optional) |         |         |                     |        |        |
| Transported air temperature [°C]   | -20...+40  |         |         | -15...+40           |        |        |
| Sound pressure level at 1 m distance [dBA]                               | 20   | 30      | 36      | 20                  | 26     | 33     |
| Sound pressure level at 3 m distance [dBA]                               | 11   | 21      | 27      | 10                  | 16     | 23     |
| Outdoor sound pressure attenuation in accordance with DIN EN 20140 [dBA] | 40 / 44  |         |         |                     |        |        |
| Heat recovery efficiency   | up to 95 %   |         |         | up to 81%           |        |        |
| Protection class   | IP24   |         |         |                     |        |        |

### Overall dimensions [mm]

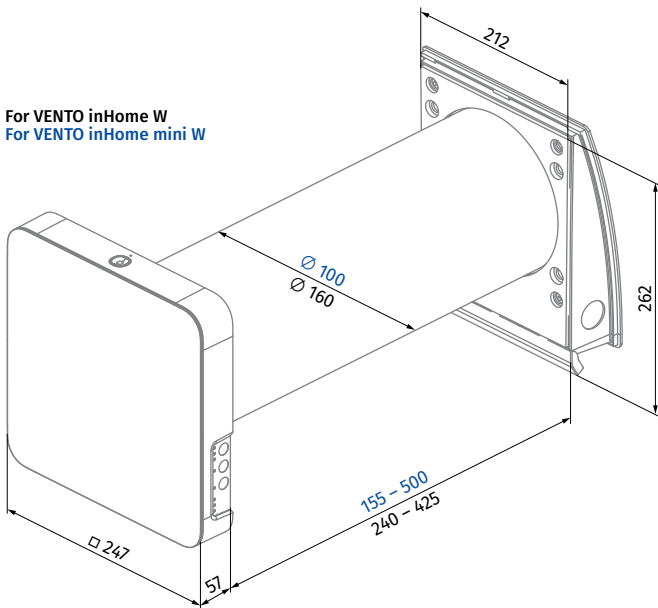

BLAUBERG Vento inHome W

41 dBA

50 m³/h

ENERGIA - ЕНЕРГИЯ - ΕΝΕΡΓΕΙΑ - ENERGIA - ENERGY - ENERGIE - ENERGI  
2023 1254/2014

BLAUBERG Vento inHome mini W

37 dBA













25 m³/h

ENERGIA - ЕНЕРГИЯ - ΕΝΕΡΓΕΙΑ - ENERGIA - ENERGY - ENERGIE - ENERGI  
2023 1254/2014

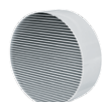
# VENTO INHOME W / VENTO INHOME MINI W











## HEAT RECOVERY SINGLE-ROOM UNITS

### Accessories

| Vento inHome                        | Vento inHome mini                        |   | Description  |
|-------------------------------------|--|---|--|
| Pre-installation Kit Vento inHome   | Pre-installation Kit Vento inHome mini   |    | Pre-installation kit for mounting into walls with standard thickness.<br>Includes:<br>• Air duct<br>• AH-11 white 160 outer ventilation hood<br>• Polystyrene foam plug<br>• Polystyrene foam wedges |
| Pre-installation Kit Vento inHome S | Pre-installation Kit Vento inHome mini S |    | Pre-installation kit for mounting into thin walls.<br>Includes:<br>• Air duct<br>• AH-S chrome 160 outer ventilation hood<br>• Polystyrene foam plug<br>• Polystyrene foam wedges                    |
| Completion Kit Vento inHome         | Completion Kit Vento inHome mini         |    | Final mounting kit.<br>Includes:<br>• Regenerator module<br>• Fan module<br>• G3 filters (2 pcs.)<br>• Indoor unit with a controller and shutters<br>• Remote control                                |
| FP2 Vento G3                        | FP3 Vento G3                             |    | G3 filters (2 pcs.)  |
| FP2 Vento G4                        |  |   | Coarse filter.<br>Includes:<br>• Plastic filter holder (1 pc.)<br>• G4 filter (1 pc.)  |
| FPC 150x50 G4                       |  |  | G4 coarse filter   |
| FP2 Vento F7                        |  |  | Filter set.<br>Includes:<br>• Plastic filter holder (1 pc.)<br>• F7 fine filter (1 pc.). Filtration rate PM2.5 > 70 %  |
| FPC 150x50 F7                       |  |  | F7 fine filter. Filtration rate PM2.5 > 70 %   |
| AH-8 white 160                      | AH-8 white 100                           |  | White painted aluminium outer ventilation hood with frost protection for a cold climate  |
| AH-8 chrome 160                     | AH-8 chrome 100                          |  | Brushed stainless steel outer ventilation hood with frost protection for a cold climate  |
| AH-10 *colour* 160                  | AH-10 *colour* 100                       |  | Plastic outer ventilation hood. Available in colours:   |
| AH-10 chrome 160                    | AH-10 chrome 100                         |  | Plastic outer ventilation hood with a plate with brushed stainless steel effect finish   |

# VENTO INHOME W / VENTO INHOME MINI W

## HEAT RECOVERY SINGLE-ROOM UNITS

| Vento inHome             | Vento inHome mini        |   | Description   |
|--------------------------|--------------------------|---|---|
| AH-11 *colour* 160       | AH-11 *colour* 100       |    | Plastic outer ventilation hood. Available in colours:       |
| AH-S white 160           | AH-S white 100           |    | Stainless steel ventilation hood, painted white   |
| AH-S chrome 160          | AH-S chrome 100          |    | Brushed stainless steel ventilation hood  |
| PP 160/0.5               | -                        |    | Outer ventilation hood for mounting from inside   |
| KIT BlauPlast white 160  | KIT BlauPlast white 100  |   | Kit for angular mounting with white colour grille (for walls with standard thickness)   |
| KIT BlauPlast chrome 160 | KIT BlauPlast chrome 100 |  | Kit for angular mounting with stainless steel outer grille (for walls with standard thickness)  |
| R 160-500                | R 100-500                |  | 500 mm air duct and polystyrene foam plug   |
| R 160-700                | R 100-700                |  | 700 mm air duct and polystyrene foam plug   |
| FB Vento Expert A50      | FB Vento Expert A50      |  | Remote control  |
| CD-1                     | CD-1                     |  | CO <sub>2</sub> sensor with LED CO <sub>2</sub> indication and a sensor button for operation mode selection   |
| CD-2                     | CD-2                     |  | CO <sub>2</sub> sensor  |